

Table of Contents

1. Introduction	5
1.1. Shock Protection Features	6
1.2. Heat Dissipation Features	6
1.3. Box Content	7
1.4. Minimum System Requirements	8
1.5. Views of the Drive	9
1.5.1. Top/Front View	9
1.5.2. Drive Mode LED Behavior	9
1.5.3. Rear View	9
1.6. Cables and Connectors	10
1.6.1. USB Cables and Connectors	10
1.6.2. FireWire Connections	10
2. Before Installing Your LaCie Rugged Safe	11
2.1. How to Use the Fingerprint Sensor	11
2.2. Being An Administrator	12
2.3. About Authorized Users and Rights	12
3. Connecting Your LaCie Rugged Safe	13
3.1. Connecting the Interface Cable	14
3.1.1. Connectivity: Installing LaCie Safe Manager	14
3.1.2. Connectivity: Ports	14
3.2. Connecting Multiple Devices	15
3.3. Connecting the Optional Power-Sharing Cable (USB)	16
3.4. Install and Run LaCie Safe Manager Software	17
3.4.1. Windows Users	17
3.4.2. Mac Users	18
3.5. Disconnecting Your Hard Drive	19
3.6. Switching Interfaces	19
4. Setting Up Your LaCie Rugged Safe	20
4.1. Step 1: Registering the First User	21
4.2. Step 2: Registering the First User's Fingerprint	22
5. Using Your LaCie Rugged Safe	24
5.1. Unlocking and Locking Your Rugged Safe	25
5.1.1. Unlocking the Drive with LaCie Safe Manager Installed	25
5.1.2. Unlocking the Drive without LaCie Safe Manager Installed	26
5.1.3. Locking the Drive	27
5.2. Manage Your Rugged Safe	28
5.2.1. Accessing the Rugged Safe Administration Page	28
5.2.2. Administration Page	30
5.2.4. Granting Administration Rights (Administrator only)	31
5.2.5. Removing Users (Administrator only)	31
5.2.6. Reinitialize the Drive (Administrator only)	31
5.3. LaCie Safe Manager Launch Preferences	32
6. Formatting Your LaCie Rugged Safe	33
6.1. One Partition for the Rugged Safe	33
6.2. Formatting Your LaCie Rugged Safe	34
6.2.1. Windows XP Users	34

6.2.2. Windows Vista and Windows 7 Users	37
6.2.3. Mac Users	41
7. Frequently Asked Questions (FAQ)	43
8. Troubleshooting	45
8.1. Troubleshooting the Hard Drive.....	45
8.1.1. Mac Users	45
8.1.2. Windows Users	47
8.2. Troubleshooting the Fingerprint Sensor	49
9. Contacting Customer Support.....	50
9.1. LaCie Technical Support Contacts	51
10. Warranty Information.....	52

Copyrights

Copyright © 2011 LaCie. All rights reserved. No part of this publication may be reproduced, stored in a retrieval system, or transmitted in any form or by any means, electronic, mechanical, photocopying, recording or otherwise, without the prior written consent of LaCie.

Trademarks

Apple, Mac, and Macintosh are registered trademarks of Apple Inc. Microsoft, Windows 98, Windows 98 SE, Windows 2000, Windows Millennium Edition, Windows XP, Windows Vista, and Windows 7 are registered trademarks of Microsoft Corporation. Other trademarks mentioned in this manual are the property of their respective owners.

Changes

The material in this document is for information only and subject to change without notice. While reasonable efforts have been made in the preparation of this document to assure its accuracy, LaCie assumes no liability resulting from errors or omissions in this document, or from the use of the information contained herein. LaCie reserves the right to make changes or revisions in the product design or the product manual without reservation and without obligation to notify any person of such revisions and changes.

Canada Compliance Statement

This Class A digital apparatus meets all requirements of the Canadian Interference-Causing Equipment Regulations.

FCC Statement

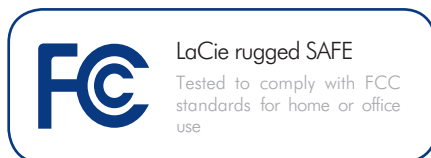

This device complies with Part 15 of the FCC Rules. Operation is subject to the following conditions:

1. The devices may not cause harmful interference
2. The devices must accept any interference received, including interference that may cause undesired operation.

NOTE: This equipment has been tested and found to comply with the limits for a Class B digital device, pursuant to Part 15 of the FCC Rules. These limits are designed to provide reasonable protection against harmful interference in a residential installation. This equipment generates, uses and can radiate radio frequency energy and, if not installed and used in accordance with the instructions, may cause harmful interference to radio communications. However, there is no guarantee that interference will not occur in a particular installation. If this equipment does cause harmful interference to radio or television reception, which can be determined by turning the equipment off and on, the user is encouraged to try and correct the interference by one or more of the following measures:

- ◆ Reorient or relocate the receiving antenna.
- ◆ Increase the separation between the equipment and receiver.
- ◆ Connect the equipment into an outlet on a circuit different from that to which the receiver is connected.
- ◆ Consult the dealer or an experienced radio/TV technician for help.

Modifications to this product not authorized by LaCie could void the FCC & Industry Canada regulations and negate your authority to operate the product.

CE Manufacturer's Declaration for CE Certification

We, LaCie, solemnly declare that this product conforms to the following European directives: 2004/108/EC (EMC), and 2006/95/EC (Safety)

CAUTION: Modifications not authorized by the manufacturer may void the user's authority to operate this device.

CAUTION: Failure to respect the precautions listed in this manual may void the LaCie Rugged Safe's warranty.



This symbol on the product or on its packaging indicates that this product must not be disposed of with your other household waste. Instead, it is your responsibility to dispose of your waste equipment by handing it over to a designed collection point for the recycling of waste electrical and electronic equipment. The separate collection and recycling of your waste equipment at the time of disposal will help to conserve natural resources and ensure that it is recycled in a manner that protects human health and the environment. For more information about where you can drop off your waste equipment for recycling, please contact your local city office, your household waste disposal service, or the shop where you purchased the product.

Health and Safety Precautions

- ◆ Only qualified persons are authorized to carry out maintenance on this device.
- ◆ Read this User Manual carefully and follow the correct procedure when setting up the device.
- ◆ Do not open a disk drive or attempt to disassemble or modify it. Never insert any metallic object into the drive to avoid any risk of electrical shock, fire, short-circuiting or dangerous emissions. The disk drive shipped with your LaCie Rugged Safe contains no user-serviceable parts. If it appears to be malfunctioning, have it inspected by a qualified LaCie Technical Support representative.
- ◆ Never expose your device to rain, or use it near water, or in damp or wet conditions. Never place objects containing liquids on the LaCie Rugged Safe, as they may spill into its openings. Doing so increases the risk of electrical shock, short-circuiting, fire or personal injury.
- ◆ Make sure that the computer and LaCie Rugged Safe are electrically grounded. If the devices are not

grounded, there is an increased risk of electrical shock. Power requirements 100-240 V~, 4A, 60-50 Hz, (Supply voltage fluctuations not exceeding $\pm 10\%$ of the nominal, transient over-voltages according to over-voltage category II).

General Use Precautions

- ◆ Do not expose the LaCie Rugged Safe to temperatures outside the range of 5° C to 35 C (41° F to 86° F); or to operational humidity beyond 5-80%, non-condensing, or non-operating humidity beyond 10-90%, non-condensing. Doing so may damage the LaCie Rugged Safe or disfigure its casing. Avoid placing your LaCie Rugged Safe near a source of heat or exposing it to sunlight (even through a window). Inversely, placing your LaCie Rugged Safe in an environment that is too cold or humid may damage the unit.
- ◆ Always unplug the LaCie Rugged Safe from the electrical outlet if there is a risk of lightning or if it will be unused for an extended period of time. Otherwise, there is an increased risk of electrical shock, short-circuiting or fire.
- ◆ Use only the power supply shipped with the device.
- ◆ Do not place objects on top of the LaCie Rugged Safe or use excessive force on it.
- ◆ Never use excessive force on your LaCie Rugged Safe. If you detect a problem, see the Troubleshooting section in this manual.

CAUTION: A shielded-type power cord is required in order to meet FCC emission limits and also to prevent interference to the nearby radio and television reception. It is essential that only the supplied power cord be used.

IMPORTANT INFO: Any loss, corruption or destruction of data while using a LaCie drive is the sole responsibility of the user, and under no circumstances will LaCie be held liable for the recovery or restoration of this data. To help prevent the loss of your data, LaCie highly recommends that you keep **TWO** copies of your data; one copy on your external hard disk, for instance, and a second copy either on your internal hard disk, another external hard disk or some other form of removable storage media. LaCie offers a complete line of CD and DVD drives. If you would like more information on backup, please refer to our web site.

IMPORTANT INFO: 1GB = 1,000,000,000 bytes. 1TB = 1,000,000,000,000 bytes. Once formatted, the actual available storage capacity varies depending on operating environment (typically 5-10% less).

1. Introduction

Thank you for purchasing the LaCie Rugged Safe. By simply connecting the drive to your computer and walking through a quick and easy software setup, you can ensure that your data is secure from unauthorized users.

The LaCie Rugged Safe performs just like a standard external hard drive, but keeps your data secure with a technology known as biometry. This emerging field is devoted to individual identification using biological traits such as fingerprints or voice recognition. Fingerprint scanning, which is the technology used by the Rugged Safe, is one of the most common biometric systems used today. By limiting access via unique fingerprinting, you can keep the data stored on your Rugged Safe secure.

LaCie Safe Manager is an intuitive program that easily manages fingerprint recognition and password protection. A software wizard guides the administrator of the LaCie Rugged Safe through the installation process.

The LaCie Rugged Safe also safeguards your data from the rigors of daily living. Shock absorbers mounted inside the casing cushion the drive from accidental impacts and an external bumper insulates the attractive exterior from abrasions.

Rugged Safe Levels of Security

- ◆ **Level 1** Biometric Access: Only authorized users can access the data.
- ◆ **Level 2** AES (Advanced Encryption Standard): The Advanced Encryption Standard (AES) is used by the US government and worldwide. The implementation of AES in products intended to protect national security systems and/or information can be reviewed and certified by the NSA prior to their acquisition and use.
- ◆ **Level 3** Password Authentication: an administrator creates a password to manage and configure the device.

Quick Links

Click a topic:

- ◆ Connecting Your LaCie Rugged Safe
- ◆ Setting Up Your LaCie Rugged Safe
- ◆ Using Your LaCie Rugged Safe



1.1. Shock Protection Features

Digital data is best handled with care, but people and their files are subject to mishaps and unfortunate accidents. In a world full of bumps, spills, and adventures, the LaCie Rugged Safe is data's best protection. See [Fig. 01](#) for a description of the LaCie Rugged Safe's physical protection design.

1.2. Heat Dissipation Features

The LaCie Rugged Safe's aluminum shell naturally dissipates internal drive heat, eliminating the need for a fan. Its unique design draws heat away from the internal drive toward the external casing. The internal drive is kept safe, prolonging its life and reliability. As a consequence, it is normal that the external casing is warm to the touch.

LaCie does not recommend stacking more than three active rugged drives on top of each other.

IMPORTANT INFO: Stacking Rugged Safe drives may make it difficult for users to access the biometric sensor or cause the sensor to read fingerprints incorrectly. LaCie recommends that you register fingerprints with the drives in the same position and orientation in which they will be used.



Fig. 01

1.3. Box Content

Your LaCie Rugged Safe should contain the following:

1. LaCie Rugged Safe
2. Hi-Speed USB 2.0 cable
3. FireWire 800 cable
4. FireWire 400 to 800 (6 pin to 9 pin) adapter cable
5. Power sharing cable
6. Quick Install Guide

IMPORTANT INFO: Please save your packaging. In the event that the drive should need to be repaired or serviced, it must be returned in its original packaging.

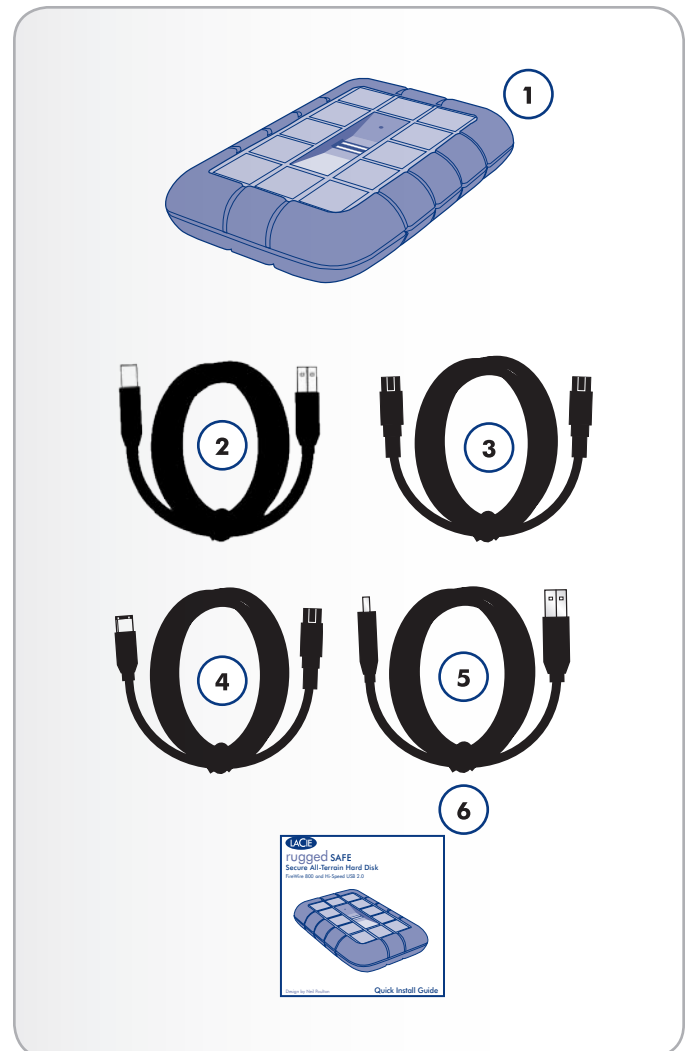

1.4. Minimum System Requirements

Operating System	Interface Port	Disk Space
The latest versions of Microsoft Windows XP, Windows Vista, or Windows 7	FireWire 400*, FireWire 800**, and/or USB 2.0	Minimum of 600MB recommended
The latest versions of Apple OS 10.5.x, or 10.6.x	FireWire 400*, FireWire 800**, and/or USB 2.0	Minimum of 600MB recommended

*The included FireWire 400 to 800 cable allows you to connect your Rugged Safe to a FireWire 400 port on a computer.

**Many computers do not have native FireWire 800 ports. To take advantage of the faster FireWire interface, you may need to purchase an expansion card for your desktop (PCI-E) or portable (Express34) computer. LaCie offers a wide selection of peripherals, including expansion cards. Visit the LaCie website at <http://www.lacie.com/us/products/family.htm?id=10012>.

TECHNICAL NOTE: To achieve USB 2.0 speeds, your drive must be connected to a USB 2.0 host port. If it is connected to a USB 1.1 port, your drive will operate at USB 1.1 speeds.

TECHNICAL NOTE: A registered user can access the Rugged Safe from any Windows or Mac computer. Please see [6. Formatting Your LaCie Rugged Safe](#) for information on how best to format the Rugged Safe.

1.5. Views of the Drive

1.5.1. Top/Front View

- 1. Biometric Fingerprint Sensor** – This is where you swipe your finger to gain access to your LaCie Rugged Safe. See section 2.1. *How to Use the Fingerprint Sensor*, for more information.
- 2. Drive Mode LED** – This LED indicates the drive mode. See the table below for details.

1.5.2. Drive Mode LED Behavior

When the LED is:	The drive is:
Blinking Red	Locked (waiting for fingerprint authentication) or fingerprint authentication failed.
Blinking Orange	Authenticating fingerprint
Static Green	Unlocked
Blinking Green	Accessing data

1.5.3. Rear View

- 1.** Power sharing cable connector
- 2.** FireWire 800 connectors
- 3.** Hi-Speed USB 2.0 connector

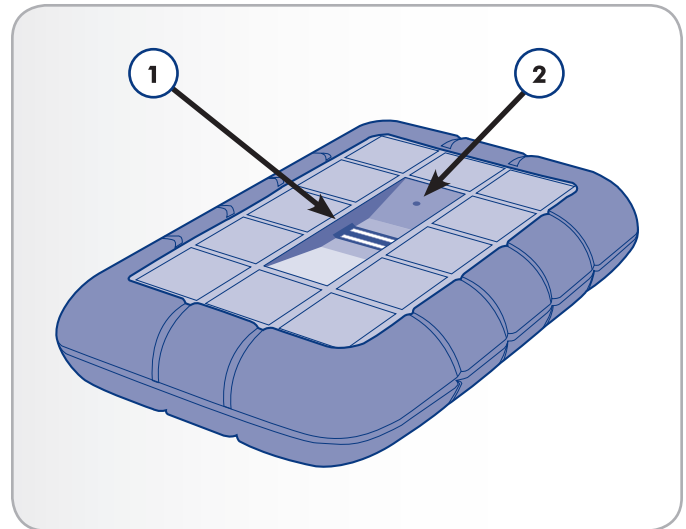

Fig. 02

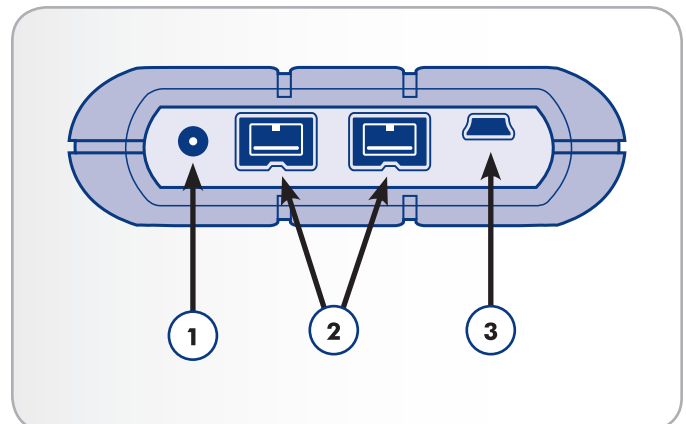

Fig. 03

1.6. Cables and Connectors

1.6.1. USB Cables and Connectors

USB is a serial input/output technology for connecting peripheral devices to a computer or to each other. Hi-Speed USB 2.0 is available on most consumer and professional workstations since it provides data transfer rates that support faster devices such as hard drives, CD/DVD drives, and digital cameras.

USB 2.0 Cables

Your LaCie drive is shipped with a Hi-Speed USB 2.0 cable, to ensure maximum data transfer performance when connected to a Hi-Speed USB 2.0 port ([Fig. 04 – USB Cable Ends](#)). The cable will also work when connected to a USB 1.1 port, but drive performance will be limited to USB 1.1 transfer rates.



Fig. 04 – USB Cable Ends

1.6.2. FireWire Connections

FireWire, also known as IEEE 1394, is a high-speed serial input/output technology for connecting peripheral devices to a computer or to each other. FireWire 800 is the implementation of the faster IEEE 1394b standard.

FireWire 800 offers increased bandwidth and extended cabling distance between devices. FireWire 800 is ideal for bandwidth-intensive applications, such as audio, video, and graphics.

FireWire 800 Cables

Your LaCie hard disk is shipped with a FireWire 800 9-to-9 pin cable ([Fig. 05 – FireWire 800 Cable Ends](#)) and a Firewire 400 to 800 6-to-9 pin cable ([Fig. 06 – FireWire 400 to 800 Cable Ends](#)).



Fig. 05 – FireWire 800 Cable Ends



Fig. 06 – FireWire 400 to 800 Cable Ends

2. Before Installing Your LaCie Rugged Safe

The LaCie Rugged Safe is unlike many other portable drives as it is built for data security, both inside and out. Please familiarize yourself with the drive's protection features before you get started.

Topic

[2.1. How to Use the Fingerprint Sensor](#)

[2.2. Being An Administrator](#)

[2.3. About Authorized Users and Rights](#)

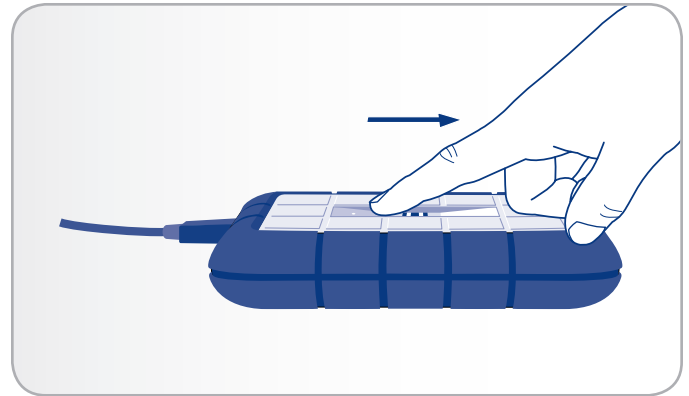

Fig. 07

2.1. How to Use the Fingerprint Sensor

To use the fingerprint sensor:

- ◆ Make sure that the front of the drive is facing you.
- ◆ Place your finger so that it is flat and resting entirely on the sensor surface.
- ◆ The tip of your finger should touch the top edge of the metal groove and the sensor.
- ◆ Slowly slide your finger over the sensor when you register a finger or authorize access. (Fig. 07)

If the sensor does not appear to recognize your fingerprint, adjust your technique according to the error reported by the sensor dialog. Refer to section [8.2. Troubleshooting the Fingerprint Sensor](#), if you are still having trouble.

IMPORTANT INFO: LaCie Safe Manager can register a maximum of ten fingerprints. Further, each user may register more than one fingerprint. For example, five users may register two fingerprints each (including the administrator); or ten fingerprints for one user. There are many combinations that allow for easy and intuitive management. See section [2.4. Rules For Registering Users](#) for more information.

2.2. Being An Administrator

The administrator has complete control over who can access the data stored on the LaCie Rugged Safe. The administrator can:

- ◆ Add or remove users
- ◆ Change a user's name or password
- ◆ Assign administrator rights to other users

Please note the following regarding administration rights:

- ◆ The first person to use the drive becomes an administrator by default. However, administrative privileges may be assigned to any user. Similarly, an administrator can have his rights adjusted to a standard user. Please note that there must be a minimum of one administrator for the LaCie Rugged Safe.
- ◆ LaCie recommends a minimum of two administrators since one person is rarely available all the time. Please note that LaCie is not liable if one or more administrators are no longer available and access to your Rugged Safe is blocked.

For more on administrator privileges, see section [5.2. Manage Your Rugged Safe](#).

2.3. About Authorized Users and Rights

When registering users, the administrator can opt to give them standard user access to data or administration privileges.

- ◆ **User** Read and write data on the drive. A user may change his password and modify the registered fingerprints.
- ◆ **Administration** Complete control of who can use the drive. For more on administrative privileges, see section [5.2. Manage Your Rugged Safe](#).

IMPORTANT INFO: LaCie highly recommends that each user register two fingerprints in case one finger is injured and must be bandaged.

IMPORTANT INFO: Once the LaCie Rugged Safe has registered ten fingerprints, the button to create additional imprints will turn grey.

For more on registering users, see section [4. Setting Up Your LaCie Rugged Safe](#).

3. Connecting Your LaCie Rugged Safe

Follow these steps to connect and power on your LaCie Rugged Safe.

Step	Topic
1	3.1. Connecting the Interface Cable
	3.2. Connecting Multiple Devices
2	3.3. Connecting the Optional Power-Sharing Cable (USB)
3	3.4. Install and Run LaCie Safe Manager Software

IMPORTANT INFO: You cannot have the FireWire and USB interfaces connected at the same time. If you would like to switch between interfaces, you must follow the steps in section [3.6. Switching Interfaces](#).

TECHNICAL NOTE: Upon completing the first registration process, you are offered the choice of formatting your LaCie Rugged Safe in FAT32 (MS-DOS). If you plan to use your drive in a cross-platform (Mac/Windows) environment, your drive should use the FAT32 (MS-DOS) file system format. See section [6. Formatting Your LaCie Rugged Safe](#), for more details. While it will erase data, you may reformat the drive at any time

CAUTION: Your LaCie Rugged Safe relies on its aluminum alloy casing to help dissipate heat. Make sure to place your drive in a well-ventilated space, do not block the ventilation outlet on the back of the drive, and keep the area in front of the drive unobstructed to allow for proper airflow.

3.1. Connecting the Interface Cable

3.1.1. Connectivity: Installing LaCie Safe Manager

Connecting the LaCie Rugged Safe to install
LaCie Safe Manager

Operating System	Port
Windows (All versions)	USB 2.0 & FireWire 400/800
Mac OS 10.6.x	USB 2.0 & FireWire 400/800
Mac OS 10.5.x	USB 2.0 only

See [3.4. Install and Run LaCie Safe Manager Software](#) for instructions on installing LaCie Safe Manager. Once the installation is finished, you may use either port for all supported operating systems.

TECHNICAL NOTE: The Rugged Safe will work on the USB 2.0 and FireWire 800 ports for all supported operating systems under most circumstances. The only limitation is the use of the USB 2.0 interface when installing LaCie Safe Manager on a computer running Mac OS 10.5.x. Please note that configuring the device (i.e. registering fingers for security, registering users, etc.) is supported on both interfaces for all supported operating systems.

3.1.2. Connectivity: Ports

1. Attach one end of an interface cable (USB 2.0, FireWire 400, or FireWire 800) to an available interface port on your computer ([Fig. 08](#)).
2. Connect the other end of the cable (USB 2.0 or FireWire 800) to the interface port on the back of the Rugged Safe.
3. If the drive is using the USB interface, connect the optional USB power sharing cable to the drive and to your computer. If the USB port on your computer provides enough power to operate the Rugged Safe, you may not require the additional power cable once the installation is complete. See [3.3. Connecting the Optional Power-Sharing Cable \(USB\)](#)
4. After a few seconds, the hard disk will mount on your computer and appear in My Computer/Computer (Windows users) or on your desktop (Mac users) as a small partition named **UTILITIES**. Windows Vista and Windows 7 users may see an AutoPlay prompt.
5. Proceed to section [3.4. Install and Run LaCie Safe Manager Software](#).

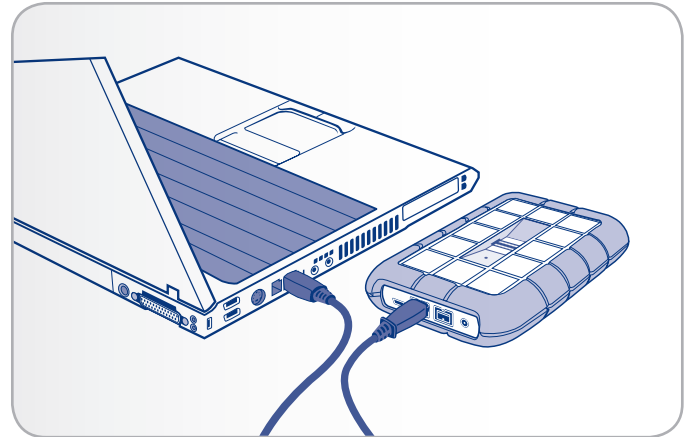

Fig. 08

IMPORTANT INFO: If your Rugged Safe does not power on within a few seconds of connecting the interface cable, follow the steps in section [3.3. Connecting the Optional Power-Sharing Cable \(USB\)](#).

TECHNICAL NOTE: To achieve Hi-Speed USB 2.0 transfer rates, the drive must be connected to a Hi-Speed USB 2.0 port on your computer. Otherwise, you will be limited to USB 1.1 data transfer rates.

TECHNICAL NOTE: For information on daisy chaining via FireWire, see section [3.2. Connecting Multiple Devices](#).

3.2. Connecting Multiple Devices

FireWire 800 allows for connecting additional hard drives or devices (i.e. digital video camera) directly to the LaCie Rugged Safe (this connection is called a “daisy chain”).

To daisy chain devices, you must use only the FireWire interface. Your computer will not recognize a daisy chained device if the interfaces are mixed. For example, a FireWire device attached to a Rugged Safe that is connected to the computer via the Hi-Speed USB 2.0 interface.

1. Connect your LaCie Rugged Safe’s host computer interface by following the steps in section. [3.1. Connecting the Interface Cable](#).
2. Attach a FireWire device to your LaCie Rugged Safe.

To attach a digital video camera*:

- a. Using an iLink/DV cable (sold separately), connect the 4-pin end of the cable to the 4-pin port on your digital camera.
- b. Connect the 9-pin end of the iLink/DV cable to the 9-pin FireWire 800 port on the back of the LaCie Hard drive.

To attach a FireWire 800 peripheral:

- a. Connect the FireWire 800 cable into an available FireWire 800 port on your FireWire peripheral.
- b. Attach the other end of the cable to an available FireWire 800 port on the LaCie Rugged Safe.

To attach a FireWire 400 peripheral:

- a. Connect the FireWire 400 end of a FireWire 400-to-FireWire 800 cable into an available FireWire 400 port on your peripheral.
 - b. Attach the other end of the cable to an available FireWire 800 port on the LaCie Rugged Safe.
3. A daisy chained drive should appear under My Computer/Computer (Windows) or on the desktop (Mac). A digital camera will be recognized by video editing software.

IMPORTANT INFO: You can not have the FireWire and USB interfaces connected at the same time. If you would like to switch between interfaces, you must follow the steps on section [3.6. Switching Interfaces](#).

TECHNICAL NOTE: When you daisy chain using a mix of interfaces (FireWire 400 and FireWire 800) the resultant speed will be limited to the lowest common denominator (FireWire 400).

Daisy-Chain Configurations

- ◆ FireWire 400 device connected directly to the LaCie Rugged Safe. The Rugged Safe is connected to the computer via the FireWire 800 port.
- ◆ iLink/DV device connected directly to the LaCie Rugged Safe. The Rugged Safe is connected to the computer via the FireWire 800 port.
- ◆ FireWire 800 device connected directly to the LaCie Rugged Safe. The Rugged Safe is connected to the computer via the FireWire 800 port.

* Some cameras do not support this configuration or may downgrade your LaCie Rugged Safe’s performance

3.3. Connecting the Optional Power-Sharing Cable (USB)

It is possible that the USB connection from your computer will not provide enough power to the LaCie Rugged Safe. To provide additional power to the Rugged Safe, attach the included USB power sharing cable to the drive from your computer.

1. Attach the small end of the power sharing cable to the back of your LaCie drive (*Fig. 09*). See [1.5.3. Rear View](#).
2. Attach the USB end of the power sharing cable to an available USB port on your computer.

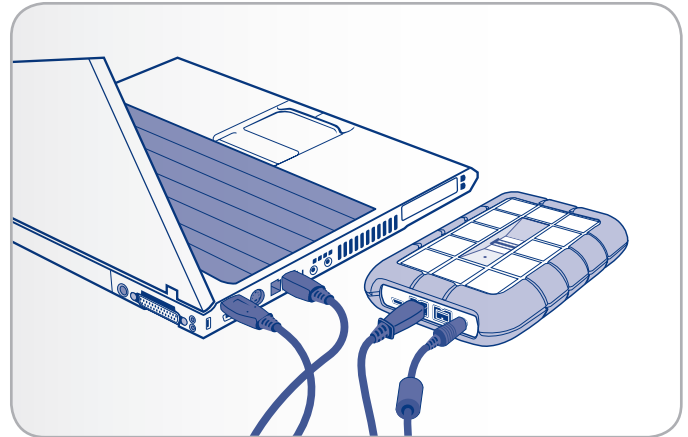

Fig. 09

3.4. Install and Run LaCie Safe Manager Software

LaCie Safe Manager will help you manage access rights to your LaCie Rugged Safe.

IMPORTANT INFO: LaCie Safe Manager is only required on one computer to configure the drive for authentication and to manage users. When attaching the LaCie Rugged Safe to a computer without LaCie Safe Manager, the drive LED blinks red and will not appear on the desktop (Mac) or in My Computer/Computer (Windows) until an authorized user has swiped his finger.

3.4.1. Windows Users

Windows users may use the USB 2.0, FireWire 400, or FireWire 800 port to install LaCie Safe Manager. See [3.7. Connecting the Interface Cable](#) for further information. When plugging the device into a Windows Vista or Windows 7 workstation, the AutoPlay window may offer a prompt to open folders on the partition. See Step 1 to select the folder.

1. Run the LaCie Safe Manager installer from the LaCie Utilities partition. The LaCie Safe Manager installer can be found in My Computer/Computer, within the **UTILITIES** disk. Inside the disk are two folders, **Software** and **Manual**. Open the **Software** folder and click twice on the LaCie Safe Manager icon.
2. The installer will launch the LaCie Safe Manager Setup Wizard. Select your language and click **OK**.
3. You'll see a window welcoming you to the Setup ([Fig. 10](#)). It is recommended that you quit all applications before running the installer. Click **Next** to continue or **Cancel** if you need to quit open applications.
4. The Setup program will now install the software.
5. When the installation is finished, a dialog window will open, confirming that the installation was successful ([Fig. 11](#)) and the computer must restart.
6. Move on to section [4. Setting Up Your LaCie Rugged Safe](#).

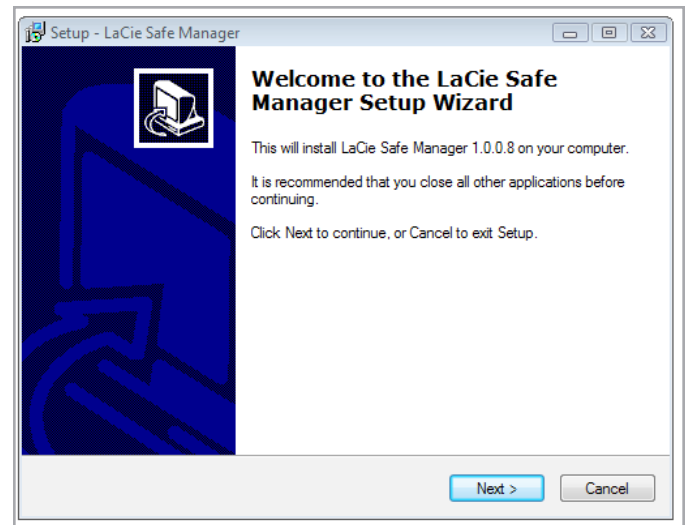

Fig. 10

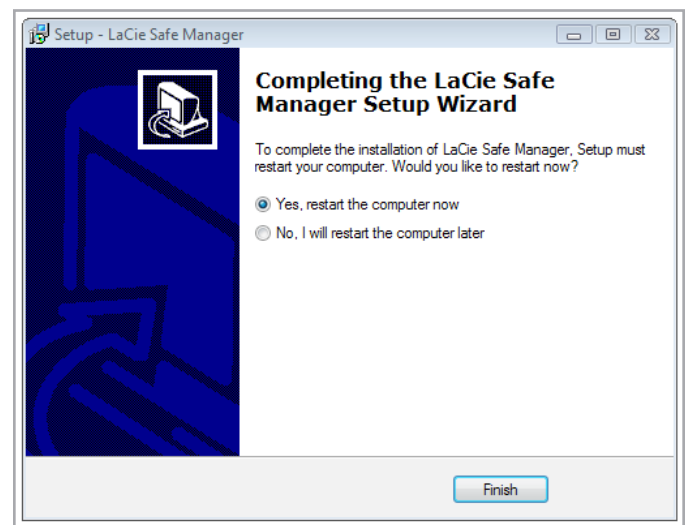

Fig. 11

3.4.2. Mac Users

Mac 10.6.x workstations may use the USB 2.0 port or the FireWire port to install LaCie Safe Manager. However, Mac 10.5.x systems should only use the USB 2.0 port for the installation. Both ports are available for configuration once the installation is complete. See 3.1. [Connecting the Interface Cable](#) for further information.

1. Run the LaCie Safe Manager installer from the LaCie Rugged Safe **UTILITIES** partition.
2. Open the **UTILITIES** partition. Find the **Software** folder and click twice on the LaCie Safe Manager installation icon.
3. The installation will begin (see [Fig. 12](#)). Follow the installation prompts to continue.
4. Enter your computer's Administrator password when asked.
5. Select **Continue Installation** when a prompt informs you that a restart is required to complete the installation ([Fig. 13](#)).
6. Once complete, a window appears noting that LaCie Safe Manager has been successfully installed. ([Fig. 14](#))

Proceed to section 4. [Setting Up Your LaCie Rugged Safe](#).

TECHNICAL NOTE: The Rugged Safe will work on the USB 2.0 and FireWire 800 ports for all supported operating systems under most circumstances. The only limitation is the use of the USB 2.0 interface when installing LaCie Safe Manager on a computer running Mac OS 10.5.x. Please note that configuring the device (i.e. registering fingers for security, registering users, etc.) is supported on both interfaces for all supported operating systems.



Fig. 12

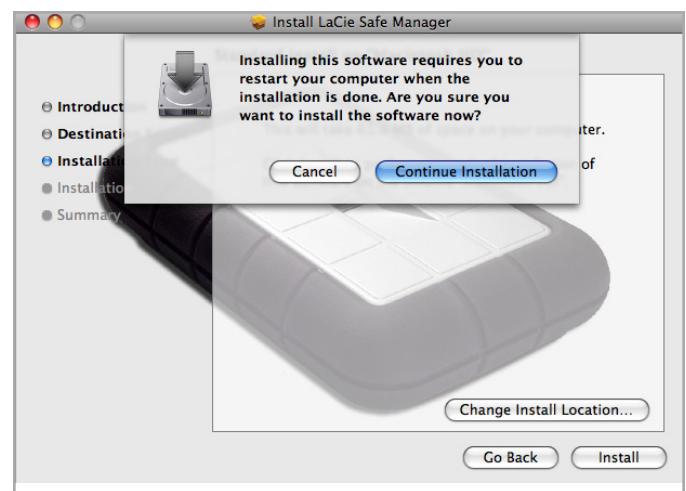

Fig. 13

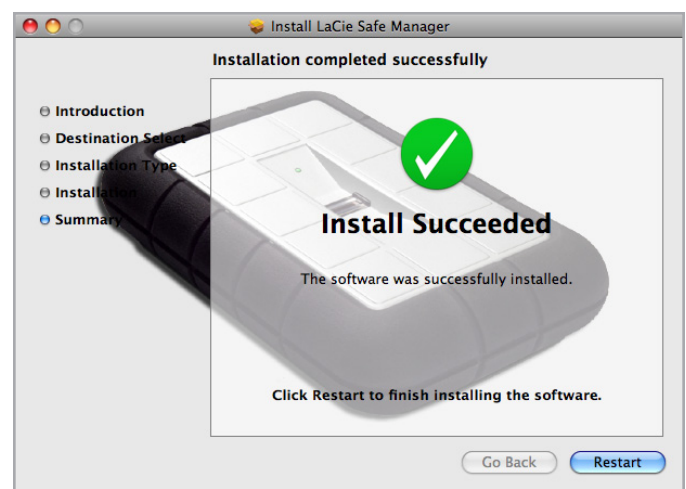

Fig. 14

3.5. Disconnecting Your Hard Drive

USB and FireWire external devices feature “plug & play” connectivity, which means that a drive can be connected and disconnected while the computer is running. To prevent failures, it is important to follow the steps below before disconnecting your hard drive.

Windows XP Users

From the System Tray located in the lower right-hand side of your screen, click on the Eject icon (a small green arrow over a hardware image) (*Fig. 15 – Windows XP Users*).

A message will appear, detailing the devices that the Eject icon controls, i.e. “Safely remove...” Select the disk you wish to unmount.

You will then be given the following message: “The USB Mass Storage Device’ device can now be safely removed from the system”. It is now safe to disconnect the device.

Windows Vista/Windows 7 Users

From the System Tray located in the lower right-hand side of your screen, click on the plug icon (note the white check mark inside a green circle). (*Fig. 16 – Windows Vista/Windows 7 Users*)

A message will appear, detailing the devices that may be safely unmounted. (*Fig. 17 – Windows Vista/Windows 7 Users*)

Select Eject for the device you wish to unmount. A message will appear notifying you that it is safe to remove the device.

Mac Users

Drag the hard drive icon to the trash (*Fig. 18 – Mac Users*).

The drive can now be disconnected.

3.6. Switching Interfaces

Since USB and FireWire devices are plug & play, you can switch the interface connectivity of your LaCie Rugged Safe while the computer is still on. To prevent failure, however, it is important to unmount your drive before switching interfaces. See section 3.5. *Disconnecting Your Hard Drive* (above), for the unmounting procedure. Once properly unmounted, you may reconnect the drive using the alternative interface.

TECHNICAL NOTE: To quickly lock your Rugged Safe drive, unmount or eject the data partition from the OS and swipe a registered finger. The LED will blink red, indicating that the drive is locked. See section 5.1. *Unlocking and Locking Your Rugged Safe* for more information on locking your drive.

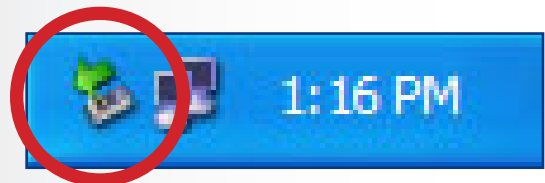

Fig. 15 – Windows XP Users



Fig. 16 – Windows Vista/Windows 7 Users

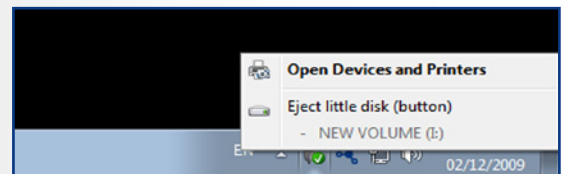

Fig. 17 – Windows Vista/Windows 7 Users



Fig. 18 – Mac Users

4. Setting Up Your LaCie Rugged Safe

The LaCie Rugged Safe must be attached to your computer to properly run LaCie Safe Manager for the first time. (3. [Connecting Your LaCie Rugged Safe](#)) Once the device is detected, LaCie Safe Manager will launch automatically. If LaCie Safe Manager is not open, you may launch the software manually.

To open LaCie Safe Manager:

Windows Users:

- ◆ In the task bar, right click the **LaCie Safe Manager** icon and select **Open LaCie Safe Manager...** (Fig. 19 & Fig. 20)
- ◆ Select **Start / Programs / LaCie Safe Manager**.

Mac Users:

- ◆ In the menu bar, click on the **LaCie Safe Manager** and select **LaCie Safe Manager...** (Fig. 21)
- ◆ In the Finder, select **Go / Applications / LaCie Safe Manager**.

IMPORTANT INFO: Screen shots in the following section are taken from a Mac. Display windows may be slightly different on your computer, depending on the operating system and personal settings.

This section consists of the following topics:

Topic

[4.1. Step 1: Registering the First User](#)

[4.2. Step 2: Registering the First User's Fingerprint](#)

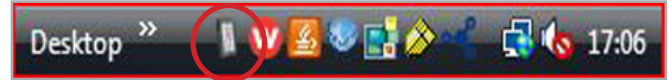

Fig. 19

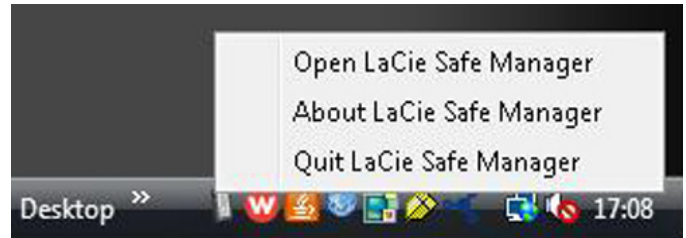

Fig. 20



Fig. 21

4.1. Step 1: Registering the First User

User Information

LaCie Safe Manager will launch automatically when your Rugged Safe is attached to your computer. Before moving forward, check that your drive is selected in the column on the left (Fig. 22).

IMPORTANT INFO: If your Rugged Safe drive does not appear in the left-hand column, please check to see if it has been properly connected. Refer to section 3. *Connecting Your LaCie Rugged Safe* for additional information.

Upon initial launch, follow the Wizard prompts:

1. Choose **Next**.
2. Enter a login name and a password (Fig. 23). You may enter letters (no accents and case sensitive) and numbers. For greater security, do not use a password that has relevance or familiarity with a large group as it may increase your security risk. To aid with the password selection, please note the password strength bar. (Fig. 24)
3. Choose **Next** and proceed to section 4.2. *Step 2: Registering the First User's Fingerprint*.

IMPORTANT INFO: The first user registered becomes an administrator by default. Any user added later can be given administrative privileges. Similarly, the default administrator may have his rights adjusted to that of a standard user. Since it is close to impossible for one person to be available all the time, LaCie highly recommends two administrators for the Rugged Safe.

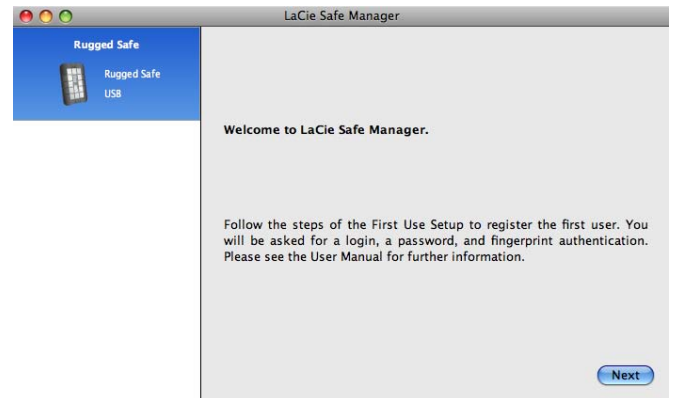

Fig. 22

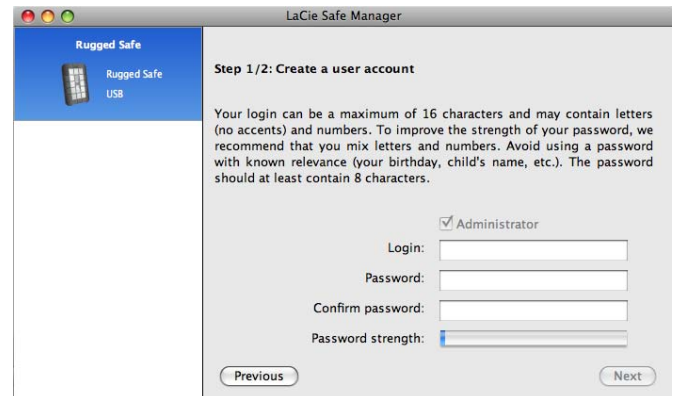

Fig. 23



Fig. 24

4.2. Step 2: Registering the First User's Fingerprint

1. To begin registering a fingerprint, click on the tip of a finger that has not been selected (Fig. 25). An available finger is indicated by a dark blue light while light blue means unavailable. The swipe dialogue appears once a finger is chosen.
2. Your finger should lie flat in the recess. Make sure the top of your finger touches the top of the recess and slide it down slowly. For more on how to use the fingerprint sensor see section 2.1. *How to Use the Fingerprint Sensor*.
3. Swipe the selected finger over the fingerprint sensor as indicated by the swipe dialog. If the swipe is successful, the dialog prompts you to swipe the same finger a second and third time for confirmation. (Fig. 26)

IMPORTANT INFO: LaCie Safe Manager can register a maximum of ten fingerprints and each user may register more than one fingerprint. For example, five users (including the administrator) may register two fingerprints each; or, ten fingerprints for one user. There are many combinations that allow for easy and intuitive management. See section 2.4. *Rules For Registering Users* for more info.

4. When you have successfully swiped your finger three times, the dialog displays three check marks and then closes (Fig. 27). The indicator on the finger that has been successfully registered will change from dark blue to light blue.
5. To register additional fingerprints, please repeat steps 1-3.
6. Register another fingerprint or click **Next** to continue.
7. Upon selecting **Next**, LaCie Safe Manager will add the user information and register the finger(s) (Fig. 28).

continued on the next page >>



Fig. 25



Fig. 26



Fig. 27



Fig. 28

- LaCie Safe Manager will ask if you want to format the drive using FAT32 for use with Windows and Mac (Fig. 29). If you prefer HFS (Mac) or NTFS (Windows), choose cancel and use your operating system's disk utility to format the Rugged Safe. Please note that you must format the drive in order to begin storing data and accessing files.

IMPORTANT INFO: Using your operating system's disk utility to format the Rugged Safe will not destroy or erase the fingerprint security that you have recorded. However, LaCie strongly recommends against formatting your Rugged Safe with more than one partition. There is a high risk of losing data when using the Rugged Safe with more than one partition. See [6.2. Formatting Your LaCie Rugged Safe](#) for more information.

- Proceed to section [6. Formatting Your LaCie Rugged Safe](#) if you have not formatted your Rugged Safe. If the drive has been formatted, got to [5. Using Your LaCie Rugged Safe](#).

IMPORTANT INFO: You must format the Rugged Safe in order to store data and access files.

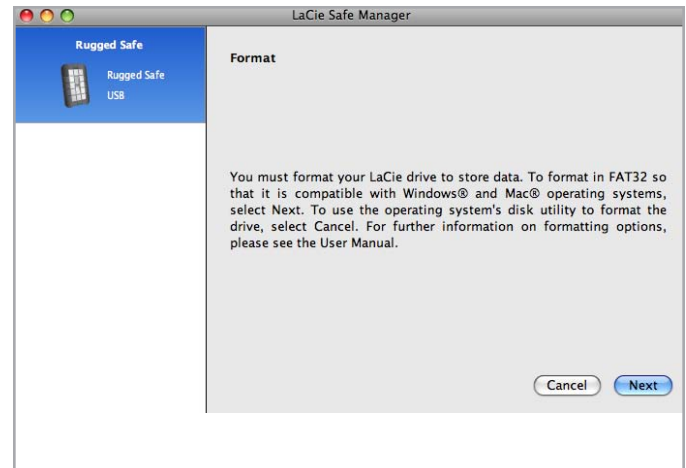

Fig. 29

5. Using Your LaCie Rugged Safe

You can start to use your LaCie Rugged Safe drive once you have successfully registered at least one user. Connect the drive to begin storing and accessing data (see section [3. Connecting Your LaCie Rugged Safe](#) for more information).

Topic
5.1. Unlocking and Locking Your Rugged Safe
5.2. Manage Your Rugged Safe
5.3. LaCie Safe Manager Launch Preferences

5.1. Unlocking and Locking Your Rugged Safe

5.1.1. Unlocking the Drive with LaCie Safe Manager Installed

IMPORTANT INFO: LaCie Safe Manager is only required on one computer to configure the drive for authentication and to manage users. When attaching the LaCie Rugged Safe to a computer without LaCie Safe Manager, the drive will not appear on the desktop (Mac) or in My Computer (Windows) until an authorized user has swiped his finger.

1. Connect the Rugged Safe to the computer ([3.1. Connecting the Interface Cable](#)).
2. The LED on top of the drive will turn solid green than solid red while the drive is initializing. A few moments later, the LED will blink red.
3. LaCie Safe Manager launches automatically, asking if the user wishes to unlock the drive for use or open the administration window.
4. To unlock the drive, you may choose to:
 - ◆ Enter a password. Click the option on the right, “Click here to unlock your device and access data.” ([Fig. 30](#)) After typing your login and password ([Fig. 31](#)), the device will unlock, allowing access to the data. You may also select the menu (Mac) or system tray (Windows) LaCie Safe Manager icons to access Unlock. You will be prompted for a login and password.
 - ◆ Swipe a registered finger. Place a registered finger flat in the recess of the fingerprint sensor. Make sure the top of your finger touches the top of the recess and slide it down slowly. If the finger swipe is successful, the device will unlock, allowing access to the data.
5. Once unlocked, the LED turns solid green indicating that the data partition is available. LaCie Safe Manager shows the drive is unlocked and offers the opportunity to manage the drive ([Fig. 32](#)). A login with administration privileges is required. You may minimize (Windows) or hide (Mac) LaCie Safe Manager, or quit since it is not required to access data.

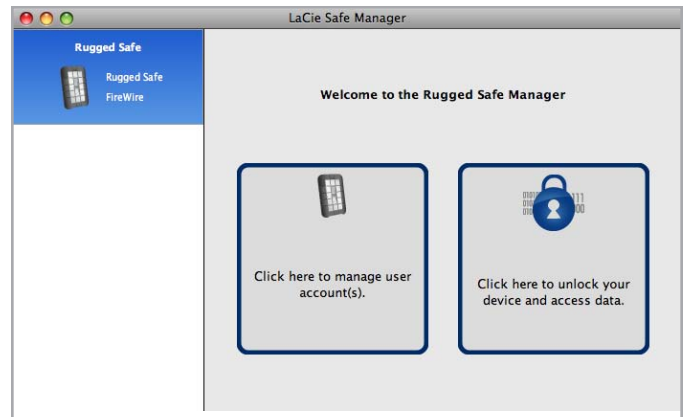

Fig. 30



Fig. 31

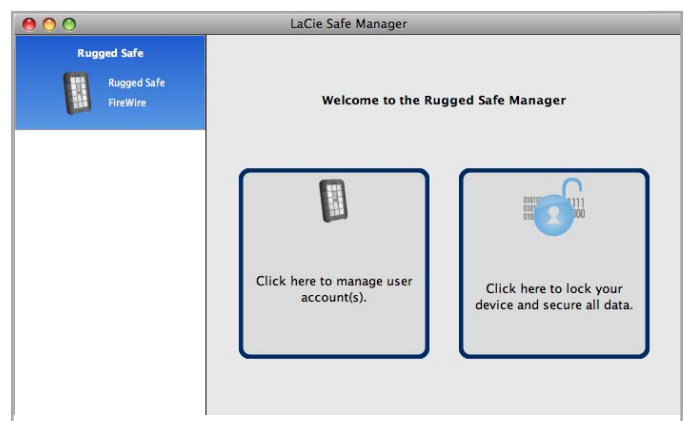

Fig. 32

5.1.2. Unlocking the Drive without LaCie Safe Manager Installed

1. Connect the Rugged Safe to the computer.
2. The LED on top of the drive will turn green then red while the drive is initializing. A few moments later, the LED will blink red.
3. Place a registered finger flat in the recess of the fingerprint sensor. Make sure the top of your finger touches the top of the recess and slide it down slowly.
4. If the finger swipe is successful, the device will unlock, allowing access to the data.

TECHNICAL NOTE: For more on how to use the fingerprint sensor see section [2.1. How to Use the Fingerprint Sensor](#). If you are experiencing trouble with the fingerprint, see section [8.2. Troubleshooting the Fingerprint Sensor](#).

5.1.3. Locking the Drive

1. Computers with or without LaCie Safe Manager may lock the drive by ejecting (Windows) or unmounting (Mac) the partition:

- ◆ Windows users may eject the device. Right-click on the drive icon in My Computer (Windows XP) or Computer (Windows Vista and Windows 7) and select Eject. The drive icon will disappear and the LED will blink red, indicating the device is locked.

IMPORTANT INFO: Using the Eject icon in the Windows system tray may not lock the Rugged Safe. LaCie recommends ejecting the device as noted above.

- ◆ Mac users should unmount the drive (see [3.5. Disconnecting Your Hard Drive](#)). Once the partition has disappeared, swipe a registered finger. The drive icon will disappear and the LED will blink red, indicating the device is locked.

IMPORTANT INFO: Mac users will generate a Device Removal error when swiping a registered finger before unmounting the device. It is best to unmount the drive before locking it.

2. For computers that are running LaCie Safe Manager:

- ◆ Click on the icon in the menu bar (Mac) or right-click the icon in the system tray (Windows). Choose [Rugged Safe > Lock](#). ([Fig. 33](#)). The data drive icon will disappear and the LED will blink red, indicating the device is locked. The LaCie [UTILITIES](#) partition will be available for access to software or documentation.
- ◆ In the LaCie Safe Manager welcome page, choose the option on the right, “Click here to lock your device and secure all data” ([Fig. 34](#)). The drive icon will disappear and the LED will blink red, indicating the device is locked. The LaCie [UTILITIES](#) partition will be available for access to software or documentation.

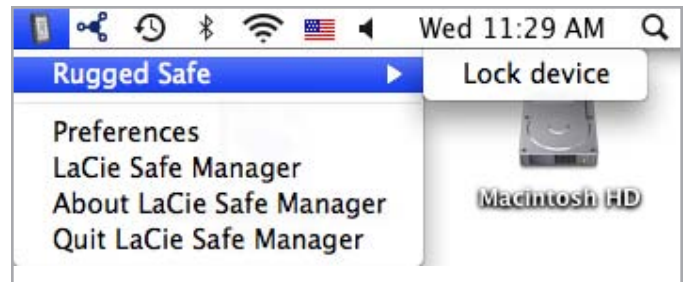

Fig. 33

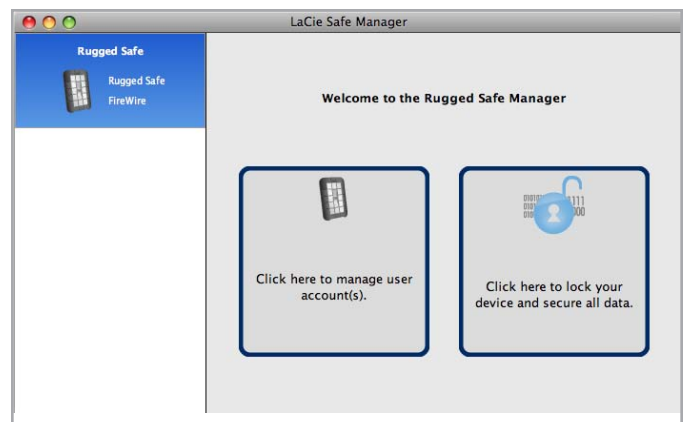

Fig. 34

5.2. Manage Your Rugged Safe

5.2.1. Accessing the Rugged Safe Administration Page

To perform administrative functions such as adding, modifying, or removing users, you must open LaCie Safe Manager. The administrator will be able to modify all users, while a non-administrator will only be able to change his own settings. The Rugged Safe may remain locked while making changes on the Administration page.

1. **Windows Users:** If it is not open, launch LaCie Safe Manager from the Start menu; or click on the LaCie Safe Manager icon in the system tray to select **Open LaCie Safe Manager**. See [4. Setting Up Your LaCie Rugged Safe](#)

Mac Users: If it is not open, launch LaCie Safe Manager from the Applications folder; or click on the LaCie Safe Manager icon in the menu bar and select **LaCie Safe Manager**. See [4. Setting Up Your LaCie Rugged Safe](#)

2. Choose the option on the left, “Click here to manage user account(s)” ([Fig. 35](#)).
3. You will be prompted to enter a login and a password ([Fig. 36](#)).

[continued on the next page >>](#)

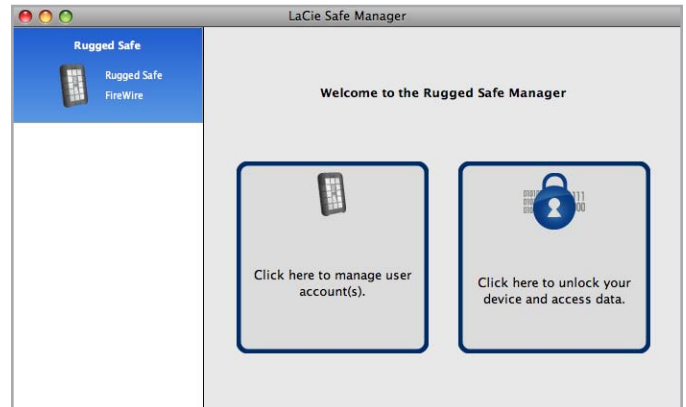

Fig. 35

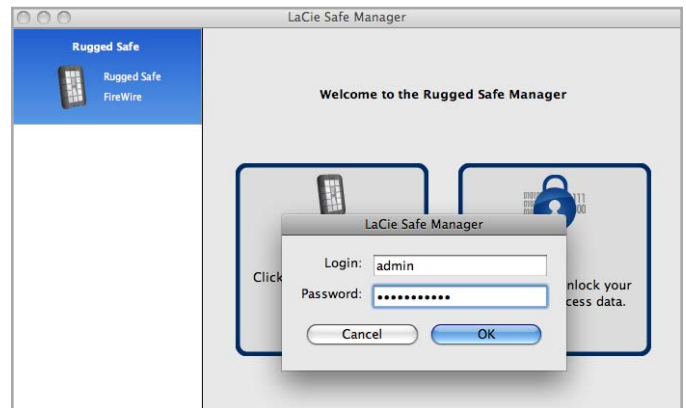

Fig. 36

- The Administration page will open if the login and password match a registered user (Fig. 37 - Administration page for a user with administration rights and Fig. 38 - Administration page for a user without administration rights).

TECHNICAL NOTE: By default, the first user registered on the Rugged Safe is an administrator. However, user rights may be changed after the initial configuration.

IMPORTANT INFO: LaCie highly recommends giving at least two people administration privileges in case one person leaves the company or is not available. LaCie is not responsible if an administrator becomes unavailable to access the data on the LaCie Rugged Safe.

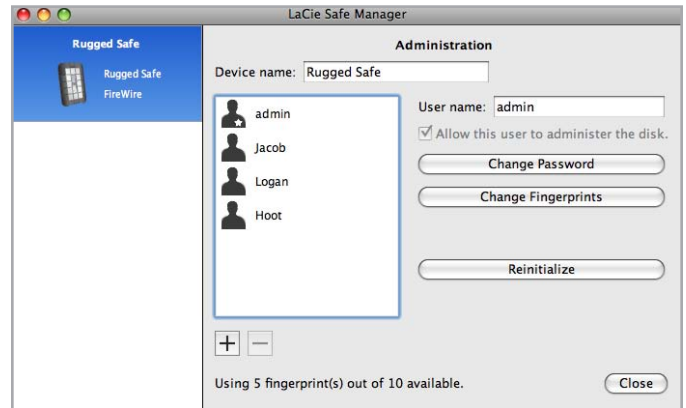

Fig. 37 - Administration page for a user with administration rights

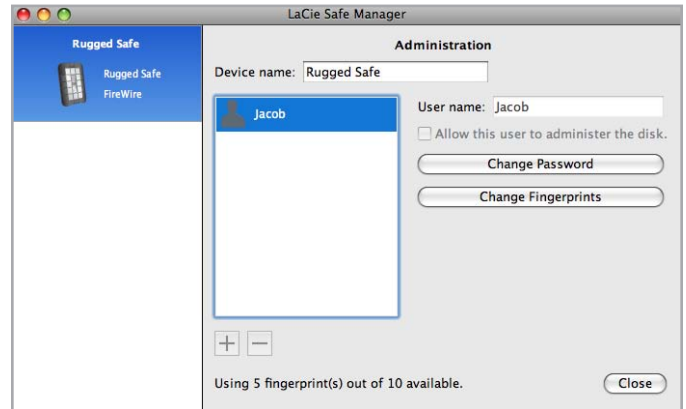

Fig. 38 - Administration page for a user without administration rights

5.2.2. Administration Page

Fig. 39 shows the Administration page when viewed with administration rights. See Fig. 38 - Administration page for a user without administration rights for an example of a user's Administration page.

The following table offers brief descriptions of each administration option and who has access (all users/administrator(s)):

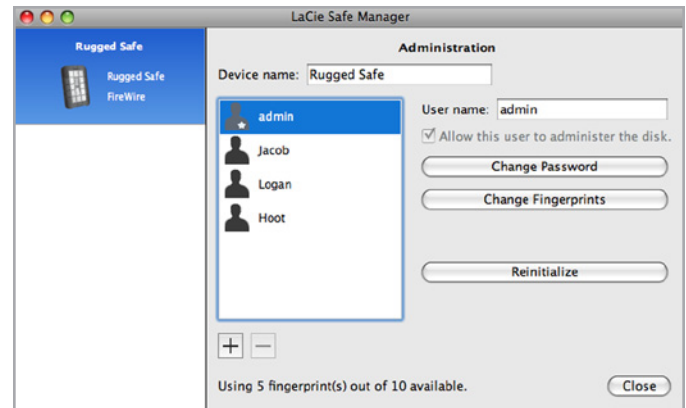

Fig. 39

Option	Access	Description
Device name	All users	<ul style="list-style-type: none"> ◆ The default name is "Rugged Safe" but all users have the right to change it at any time. ◆ Please note that this is not the name of the partition.
User name	Administrator(s)	<ul style="list-style-type: none"> ◆ Clicking on one of the user names allows an administrator to change any of the login names. ◆ For example, if an administrator wanted to change the default ("admin") for the first registered user to his own first name. Similarly, an administrator can select another user and change the name. ◆ Only an administrator can change User names.
Allow this user to administer the disk	Administrator(s)	<ul style="list-style-type: none"> ◆ Only an administrator may grant administrator rights to a user. See 5.2.3. Granting Administration Rights (Administrator only) for more information.
Change Password	All users	<ul style="list-style-type: none"> ◆ A user may change his own password. ◆ An administrator may change the passwords for all users.
Change Fingerprints	All users	<ul style="list-style-type: none"> ◆ Each user or administrator may only change his own fingerprints. An administrator may not change the fingerprints of another user. The steps to modifying or add fingerprints are similar to 4.2. Step 2: Registering the First User's Fingerprint. ◆ Fingerprints may only be added if the ten fingerprint limit has not been met. For example, Fig. 39 includes a note on the bottom of the page that reads, "Using 5 fingerprint(s) out of 10 available". This means that five more fingerprints may be registered. ◆ Users may also remove registered fingerprints.
Reinitialize	Administrator(s)	<ul style="list-style-type: none"> ◆ Reinitializing the Rugged Safe will delete all data and all user information. No files, documents, or media stored on the data partition will remain. New users and administrators must be created after reinitializing the device. See 5.2.5. Reinitialize the Drive (Administrator only) ◆ The Utilities partition will be available after Reinitializing the Rugged Safe.
+ & -	Administrator(s)	<ul style="list-style-type: none"> ◆ Click the "+" to add a user. The steps to adding a new user are similar to 4.1. Step 1: Registering the First User. ◆ Select a user and click on the "-" to remove him. See 5.2.4. Removing Users (Administrator only).

IMPORTANT INFO: Once the LaCie Rugged Safe has registered ten fingerprints, the button to create additional imprints (the "+" sign) will turn grey. You must subtract existing fingerprints to include new users.

5.2.3. Granting Administration Rights (Administrator only)

1. Click on one of the current users. In *Fig. 40*, the user Jacob has been selected. Note that there is no star on the user icon and that the option “Allow this user to administer the disk” has become available.
2. Check the box next to “Allow this user to administer the disk”.
3. LaCie Safe Manager will modify the user account, allowing Jacob to have administrator rights. The icon for Jacob now includes a star (*Fig. 41*), marking him as an administrator.

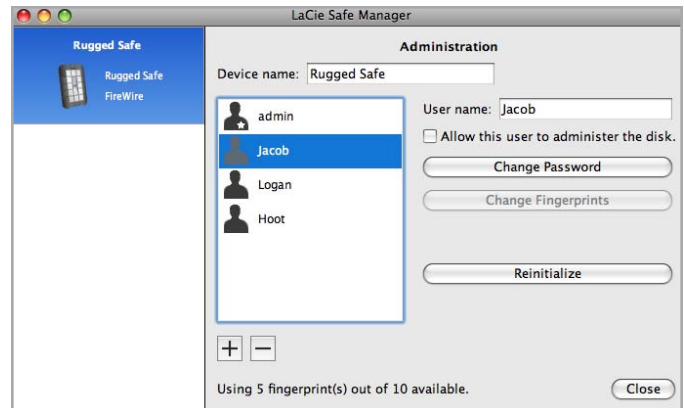

Fig. 40

IMPORTANT INFO: LaCie highly recommends giving at least two people Administration privileges in case one person leaves the company or is not available. LaCie is not responsible if an administrator becomes unavailable to access the data on the LaCie Rugged Safe.

5.2.4. Removing Users (Administrator only)

To remove a user:

1. Select the user’s name from the user list on the main configuration screen.
2. Click on the “-” symbol.
3. A confirmation dialog opens (*Fig. 42*), asking if you want to remove the user. Click **Yes** to confirm the deletion. This action cannot be undone.

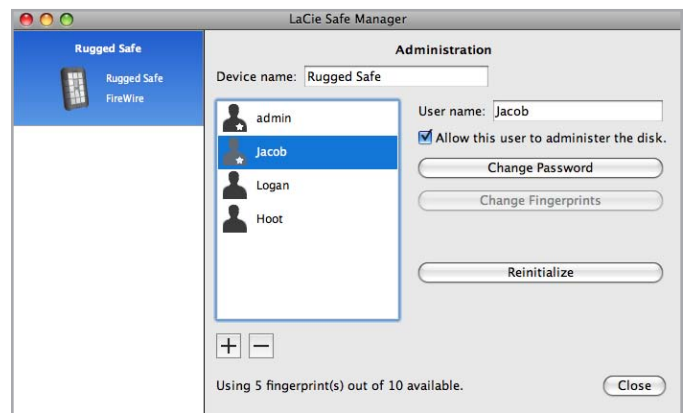

Fig. 41

5.2.5. Reinitialize the Drive (Administrator only)

To reset the drive to factory settings, click **Reinitialize**. A confirmation dialog opens, asking if you are sure you want to remove all user information and delete all the data stored on the drive (*Fig. 43*). Click **Yes** to confirm the deletion. This action cannot be undone and will delete all files and user information from the drive.

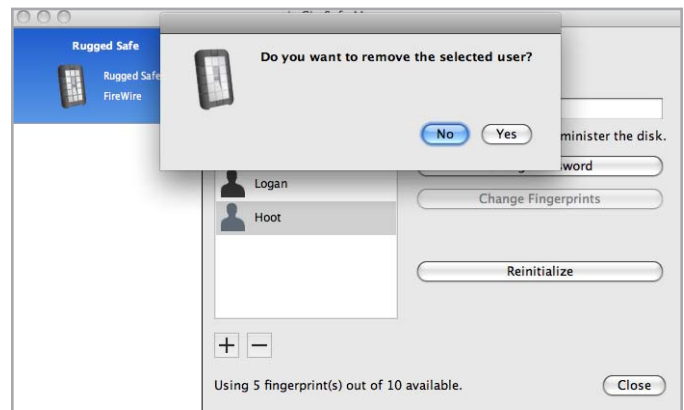

Fig. 42

IMPORTANT NOTE: Since reinitializing the drive deletes the encryption key, it is an excellent practice before redeploying the Rugged Safe.

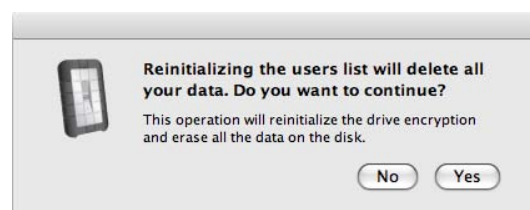

Fig. 43

5.3. LaCie Safe Manager Launch Preferences

To make adjustments on how LaCie Safe Manager launches, select the Rugged Safe icon in the menu bar (Mac) or right-click in the system tray (Windows). Choose **Preferences**. (Fig. 44).

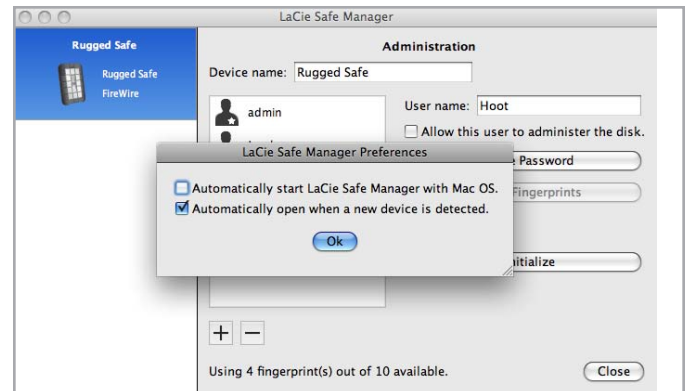

Fig. 44

6. Formatting Your LaCie Rugged Safe

The first user registration asks if you would like to format your LaCie Rugged Safe in FAT32. FAT32 is a file system best used when sharing a drive between Mac and Windows operating systems. You may elect not to format the drive in FAT32 if you prefer to use your Rugged Safe with a file system optimized for a specific operating system. Please note that you may change the file system at any time, though the formatting process will erase all data on the disk drive.

What is Formatting?

Formatting a disk entails the following: the operating system erases all of the bookkeeping information on the disk; tests the disk to make sure that all of the sectors are reliable; marks bad sectors (i.e., those that are scratched); and creates internal address tables that it later uses to locate information. LaCie Safe Manager offers to format your drive when first used, but you can elect not to, or reformat by following the instructions in this section.

Formatting includes the option to divide a hard drive into sections, called partitions. A partition is a fraction of the hard drive's storage capacity that is created to contain files and data. LaCie does not support using the Rugged Safe with more than one data partition.

6.1. One Partition for the Rugged Safe

Please note that LaCie does not support using the Rugged Safe with more than one partition. Dividing the Rugged Safe into more than one partition may create problems when operating the device and a loss of data.

LaCie Safe Manager formats the device into one FAT32 partition but you may choose to format in HFS or NTFS. No matter the format, please do not divide the disk into more than one partition since LaCie cannot guarantee optimal performance and you risk losing data.

File System Formats

There are three different file system format categories: FAT32 (MS-DOS), NTFS, and Mac OS Extended (HFS+). See the table below for more information.

Use NTFS if:

...you will be using the drive only with Windows XP, Windows Vista, or Windows 7 since performance will generally be greater compared to FAT32. This file system is compatible in read only mode with Mac OS 10.3 and higher.

Use HFS+ if:

...you will be using the drive only with the Mac OS since performance will generally be greater compared to FAT32. This file system is not compatible with Windows.

Use FAT32 if:

...you will be using your drive with both Windows and Mac OS 9.x or 10.x.

TECHNICAL NOTE: FAT32 (MS-DOS) is recommended for sharing a hard drive with Mac and Windows. However, the FAT32 file system generally runs slower than HFS+ (Mac) or NTFS (Windows). FAT32 also has a single file size limit of 4GB.

IMPORTANT INFO: Reformatting will erase everything from the hard drive. Back up any data that you want to preserve before reformatting.

6.2. Formatting Your LaCie Rugged Safe

6.2.1. Windows XP Users

The steps listed below will help you format and partition your disk drive using Windows XP. Please see [6.2.2. Windows Vista and Windows 7 Users](#) or [6.2.3. Mac Users](#) for instructions on formatting using alternative operating systems. For more information on the optimal file format, go to [6. Formatting Your LaCie Rugged Safe](#).

CAUTION: Following these steps will erase everything from the hard drive. Please back up all data that you want to preserve before formatting your drive.

1. Connect the drive to the computer via the interface port.
2. Right-click **My Computer** and select **Manage**.
3. From the “Computer Management” window, select **Disk Management** (located below the Storage group).
4. If the “Initialize and Convert Disk Wizard” window appears, click **Cancel**.
5. Windows will list the hard drives that are installed on the system. Locate your LaCie hard disk drive ([Fig. 45](#)). If there is a red circle with a white line, you must initialize the disk. Right-click the icon to select **Initialize**.
6. In the rectangular box to the right that says “Unallocated” or lists partitions from a previous format, right-click and select **New Partition...**
7. On the first page of the New Partition Wizard, click **Next** ([Fig. 46](#)).
8. Select the **Primary** or **Extended** option ([Fig. 47](#)) and click **Next**

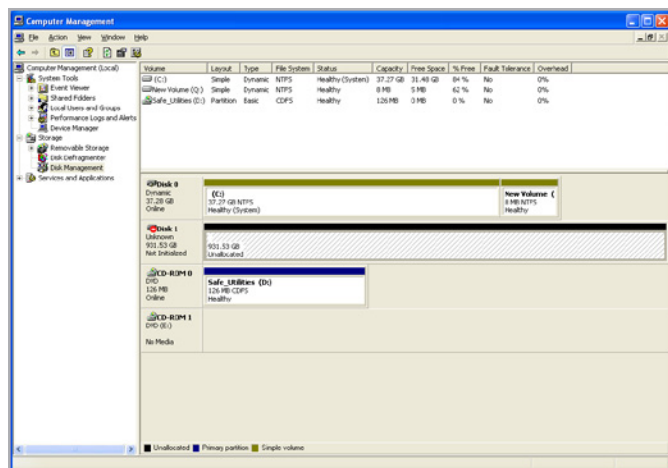

Fig. 45

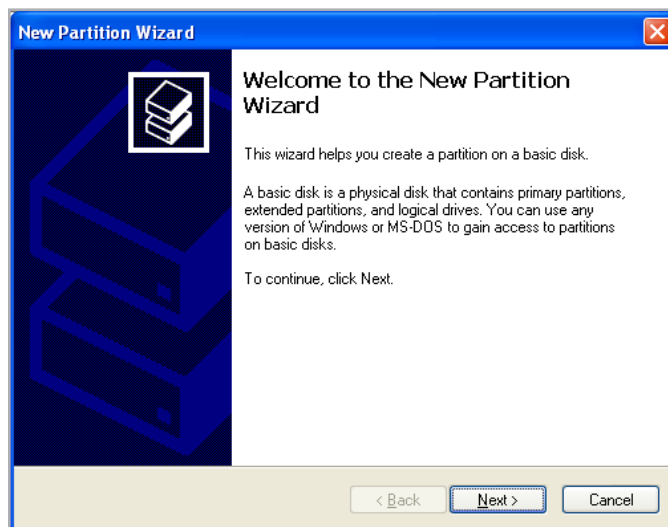

Fig. 46

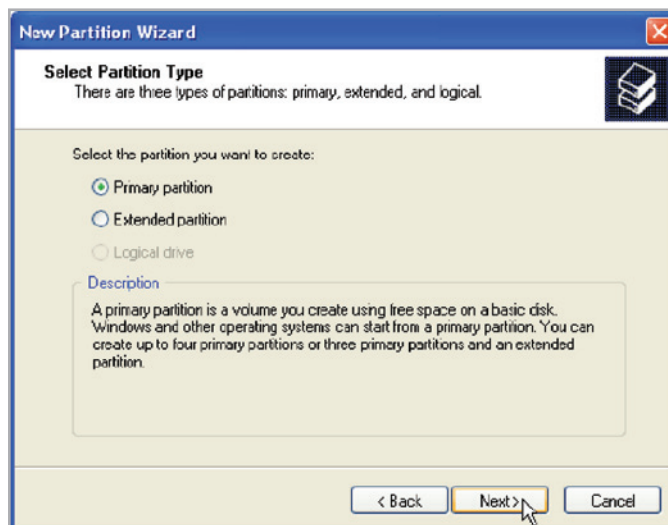

Fig. 47

continued on the next page >>

- Specify the partition size. By default, the partition occupies the entire volume (Fig. 48) but you may change the size based upon the working environment. Click **Next**.

IMPORTANT INFO: LaCie does not support using the Rugged Safe with more than one partition. See 6.1. *One Partition for the Rugged Safe* for further information.

- Assign a drive letter or mount path (Fig. 49). Click **Next**.
- Select the file format for the disk (FAT32 will only appear as an option if the partition is 32GB or less - see 6. *Formatting Your LaCie Rugged Safe*). Once FAT32 or NTFS has been selected (Fig. 50), you have the option to **Perform a quick format**, which allows for a much faster format. While Disk Management does not check the drive for errors as extensively with a quick format, the option does save time. Click **Next**.

continued on the next page >>

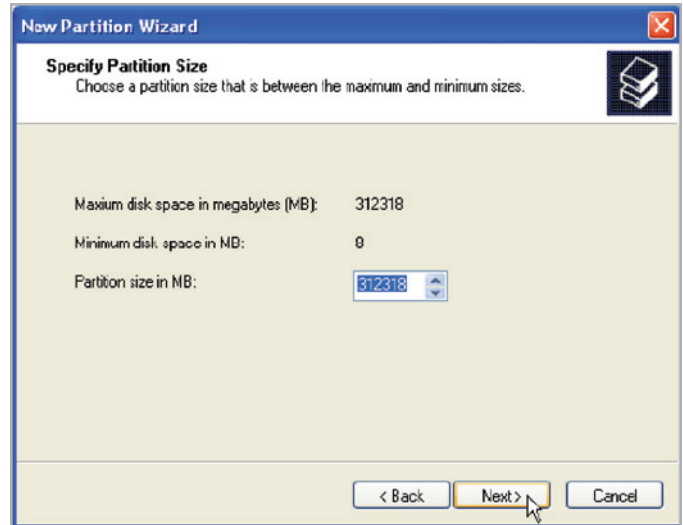

Fig. 48

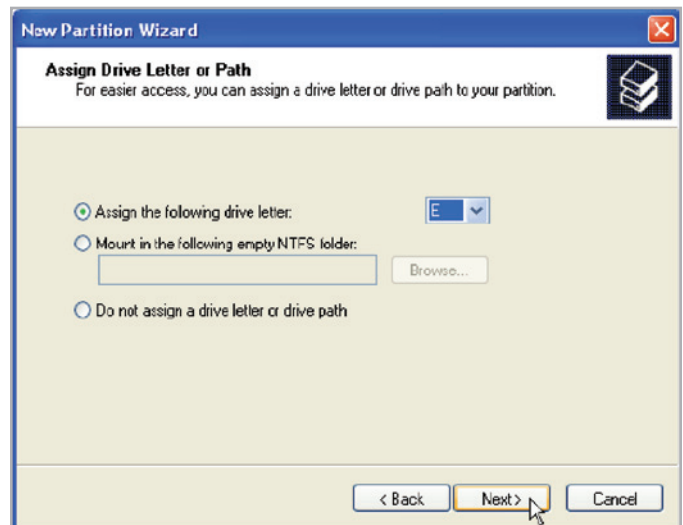

Fig. 49

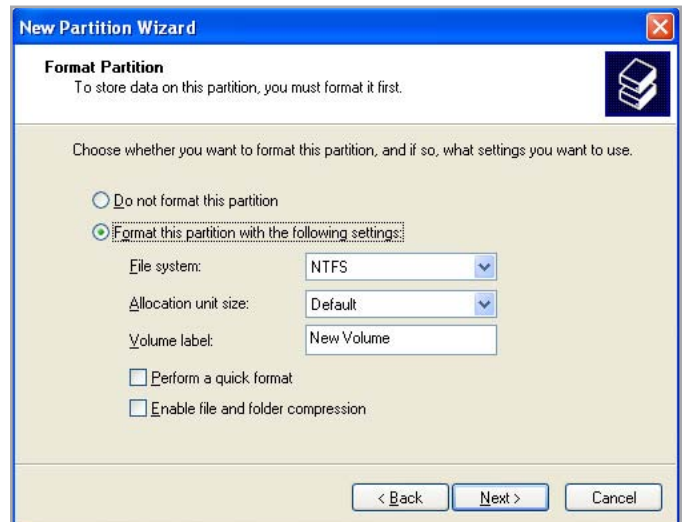

Fig. 50

12. A window appears listing your choices. If all seems well, click **Finish** to begin the format process (Fig. 51). To make a change, select **Back**.
13. Your drive's partition should have a "Healthy" status in the list of drives in Disk Management (Fig. 52). You will also see the drive's partition in My Computer. The drive is ready for use.

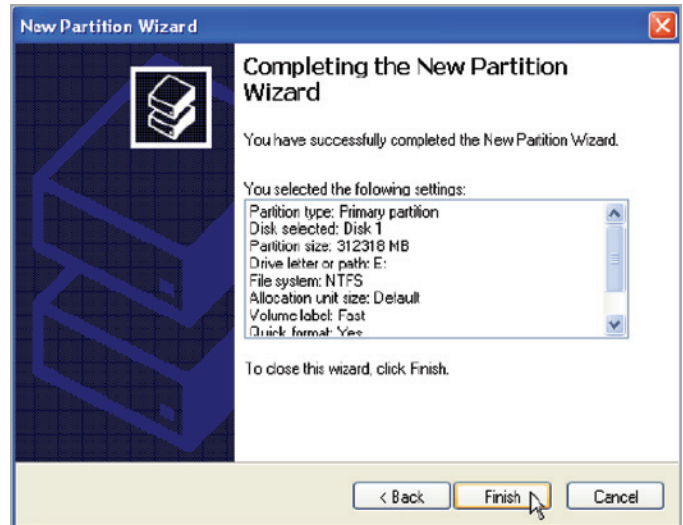

Fig. 51

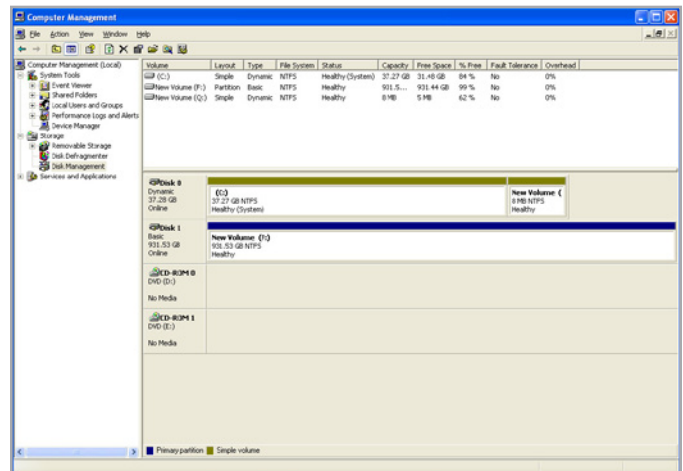

Fig. 52

6.2.2. Windows Vista and Windows 7 Users

Master Boot Record or GUID Partition Table?

Master Boot Record (MBR) partitioning has been the hard drive standard for many years. It supports a maximum of four primary partitions with a size limit of 2TB per partition. Due to partition limitations in the face of ever-expanding hard disk drive sizes, Global Unique Identifier Partition Tables (GPT) has been established to allow for more partitions with greater capacities. Further, GPT has many additional advantages that may offer enhancements in performance.

However, GPT is not compatible with Windows XP 32-bit. While Windows XP 64-bit supports GPT, it is best to use MBR if you intend to share your LaCie device with computers running Windows XP 32-bit.

Switching from MBR to GPT or, conversely, from GPT to MBR, is not difficult. Please copy all important data to a separate disk before making the change since adjusting the partition table format is destructive:

Right-click on **Computer** and choose **Manage**. From the **Manage** window select **Disk Management** and find your LaCie disk drive. Right-click on the disk number to choose GPT (Fig. 54) or MBR (Fig. 55).

The steps listed below will help you format and partition your disk drive using Windows Vista or Windows 7. Please see 6.2.1. *Windows XP Users* or 6.2.3. *Mac Users* for instructions on formatting using alternative operating systems. For more information on the optimal file format, go to 6. *Formatting Your LaCie Rugged Safe*.

1. Right-click on **Computer** and choose **Manage**. From the **Manage** window select **Disk Management**.
2. From the list of drives in the middle of the **Disk Management** window, right-click on your LaCie hard drive. Select **New Simple Volume...** (Fig. 53)

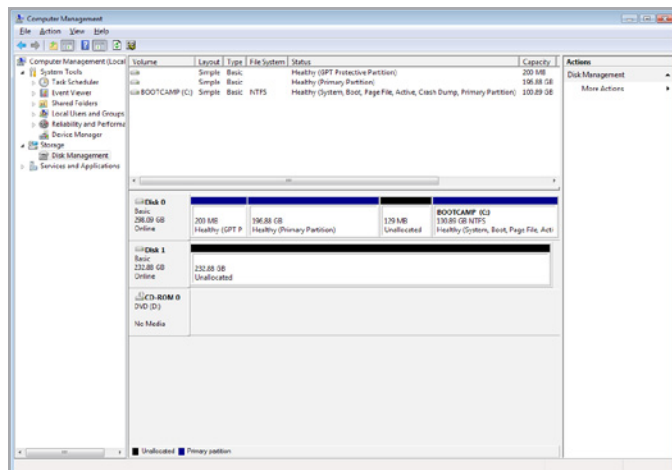

Fig. 53

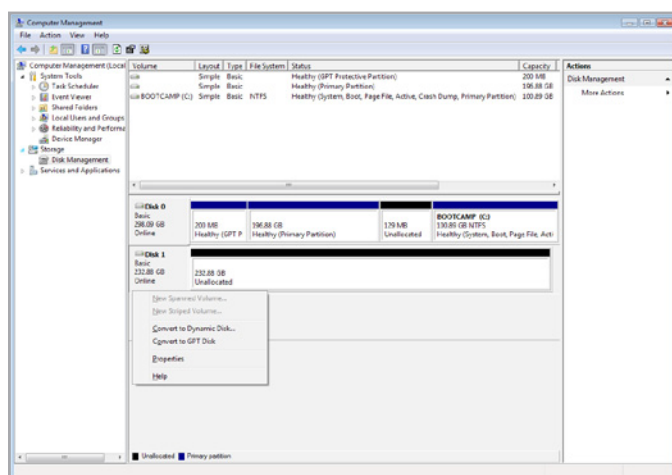

Fig. 54

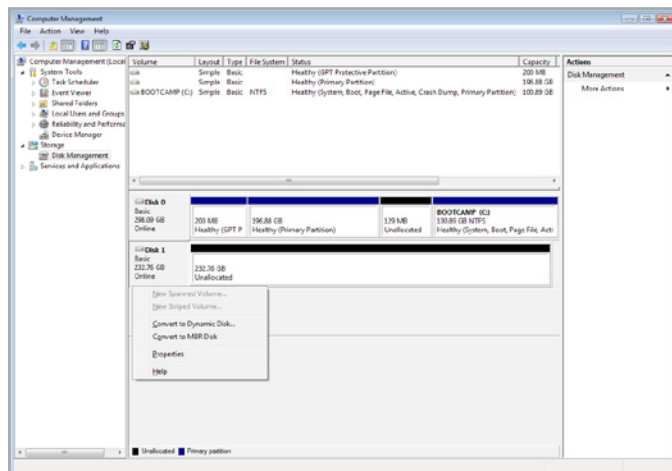

Fig. 55

3. The **New Simple Volume Wizard** will appear. To continue choose **Next**. (Fig. 56)
4. This wizard allows you to create volumes, also known as partitions. You can choose to create a single partition or many. Type the size of the partition you want to create in megabytes (MB). For example, a 100GB (gigabyte) partition is 100000MB. If you want to create a FAT32 partition, the size cannot exceed 32GB (32000MB). (Fig. 57) Once you have chosen a partition size, select **Next**.

IMPORTANT INFO: LaCie does not support using the Rugged Safe with more than one partition. See [6.1. One Partition for the Rugged Safe](#) for further information.

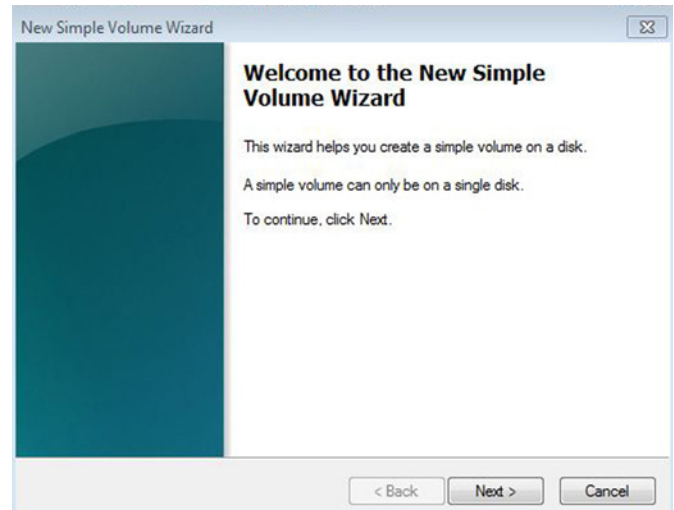

Fig. 56

continued on the next page >>

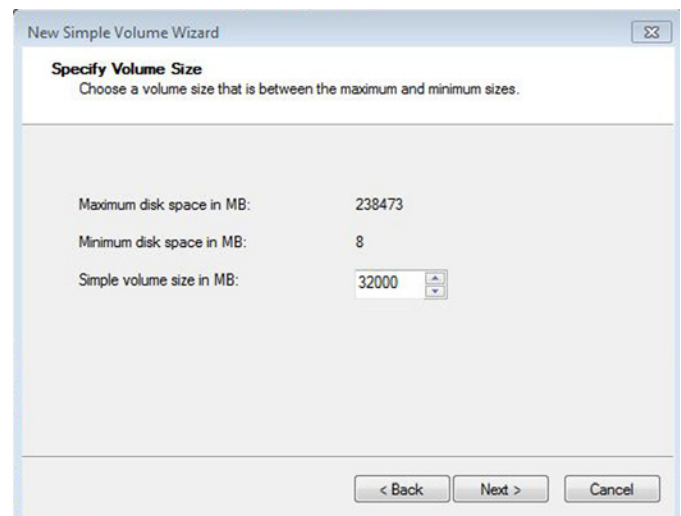

Fig. 57

5. Assign a drive letter or accept the default. (Fig. 58) Select **Next**.
6. Choose the file system format for the partition. If the partition size is 32GB or less, the choices will include **NTFS** and **FAT32**. Once the format is selected, you may check **Perform a quick format**, which allows for a much faster format. While Disk Management does not check the drive for errors as extensively with a quick format, the option does save time (Fig. 59). Select **Next**.

continued on next page >>

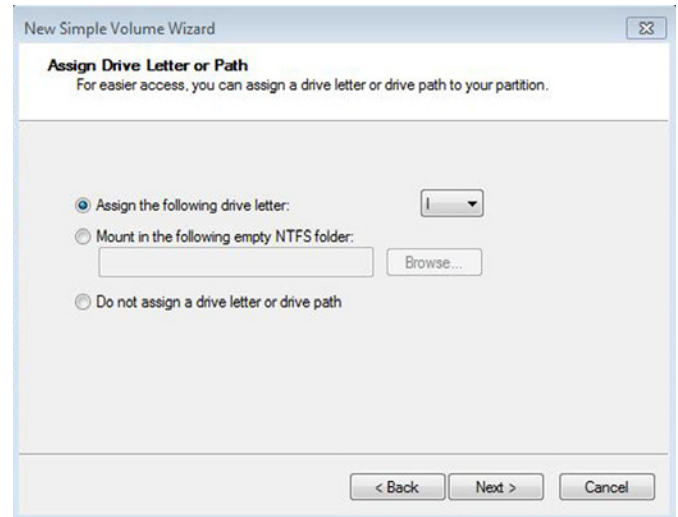

Fig. 58

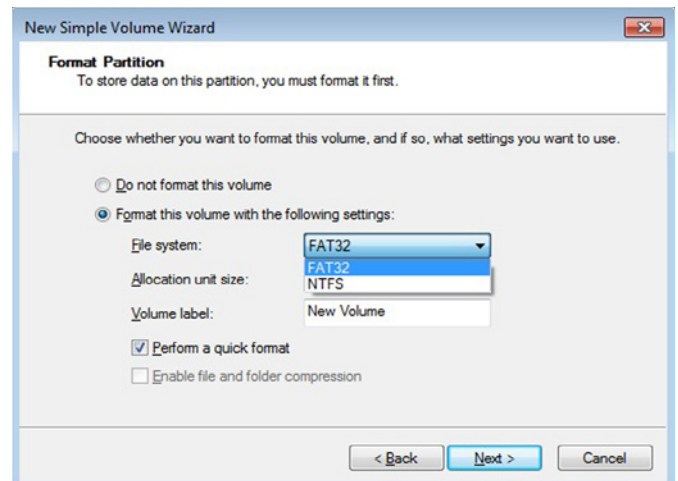

Fig. 59

TECHNICAL NOTE: Windows Vista SP1 and Windows 7 offer the exFAT file system, which is not limited to partitions less than 32GB (Fig. 60). Used primarily with USB flash drives, the exFAT file system overcomes many of the limitations of FAT32. In addition to Windows Vista SP1 and Windows 7, the exFAT file system can work on Windows XP SP2 with a special driver. Mac OS support is questionable, which limits sharing your LaCie drive between Windows and Apple operating systems. LaCie does not support using the Rugged Safe with the exFAT file system.

7. The last window is a summary of the format options you have just selected. If all looks to be correct, click **Finish** for the format to begin (Fig. 61).
-

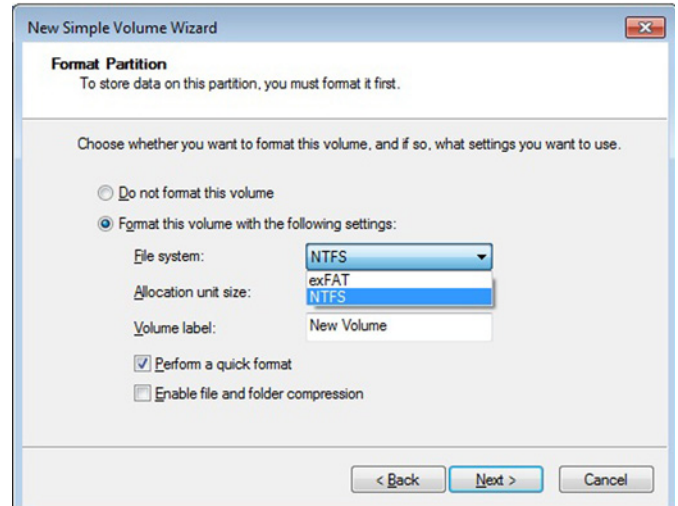

Fig. 60

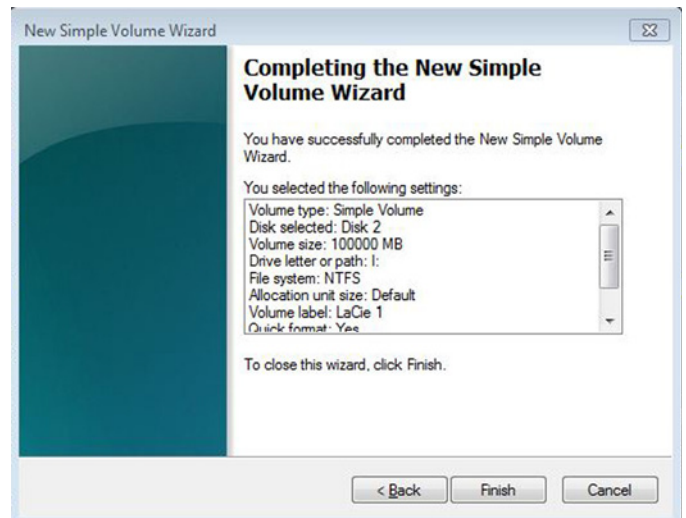

Fig. 61

6.2.3. Mac Users

The steps listed below will help you format and partition your disk drive using Mac OS X. Please see [6.2.1. Windows XP Users](#) or [6.2.2. Windows Vista and Windows 7 Users](#) for instructions on formatting using alternative operating systems. For more information on the optimal file format, go to [6. Formatting Your LaCie Rugged Safe](#).

CAUTION: Following these steps will erase everything from the hard drive. Back up all data that you want to protect or continue to use before you format the disk drive.

1. Connect the drive to the computer via the interface port.
2. Select **Utilities** from the **Go** menu in the Finder menu bar.
3. In the Utilities folder, double-click **Disk Utility**.
4. The Disk Utility window will open ([Fig. 62](#)). Select your LaCie hard disk drive from the list of available hard disks on the left side of the window.
5. Select the **Partition** tab ([Fig. 63](#)).

continued on the next page >>

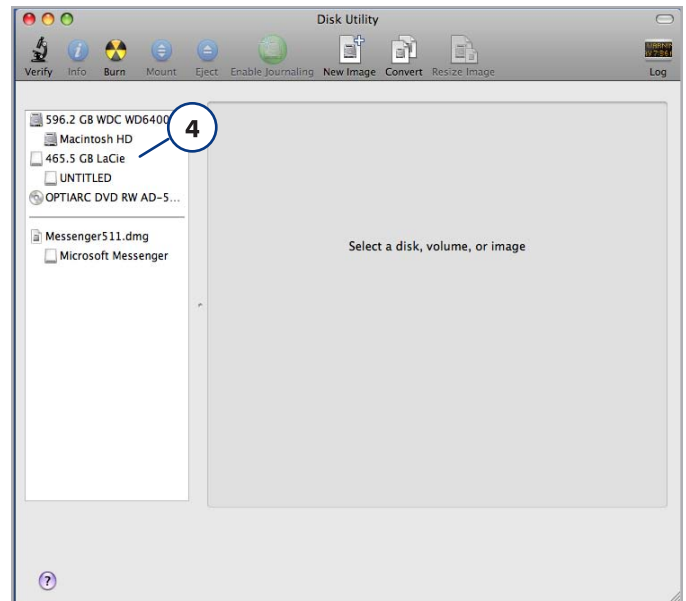

Fig. 62

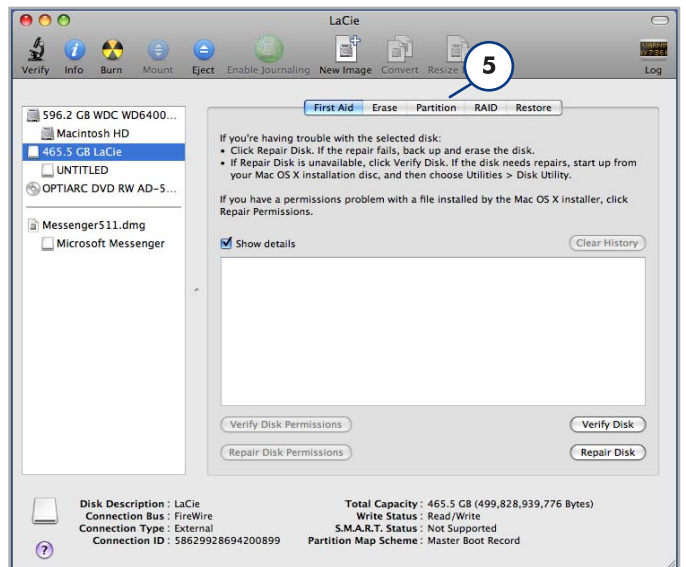

Fig. 63

IMPORTANT INFO: LaCie does not support using the Rugged Safe with more than one partition. See 6.1. *One Partition for the Rugged Safe* for further information.

6. From the **Volume Scheme:** menu, choose the number of partitions for the disk drive using the pull-down menu (Fig. 64 (6a) - Mac OS X gives you the option of dividing the drive into a maximum 16 partitions). You can adjust the size of each partition using the slide bar between the partitions in the **Volume Scheme:** area (Fig. 64 (6b)) or write the size manually in the Size box. (Fig. 64 (6c)).
7. Click on a volume (partition) in Volume Scheme so that a name can be entered in the Volume Information section (Fig. 64 (7a)). From the volume Format pull-down list (Fig. 64 (7b)), select one of the following Mac formats: **Mac OS Extended (Journaled)**, **Mac OS Extended (Case-sensitive, Journaled)**, **Mac OS Extended (Case-sensitive)** or **Free Space**. To format a partition FAT32, you must select **Options...** (Fig. 64 (7c)) below the list of partitions and choose the radio button for **Master Boot Record** (Fig. 65). **MS-DOS (FAT)** will appear on the pull-down list of Formats (Fig. 64 (7b)).
8. Once you have finalized the volume options, click **Apply** (Fig. 64 (8a)). Click **Partition** (Fig. 66) when the alert message appears.
9. Disk Utility will format and partition the disk according to your settings. Once finished, the partition(s) will appear on your desktop, indicating the disk drive is ready for use.

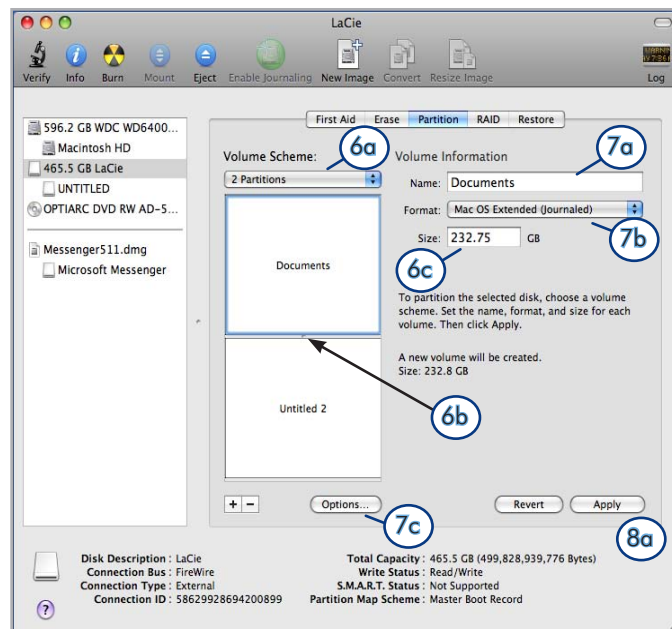

Fig. 64



Fig. 65



Fig. 66

7. Frequently Asked Questions (FAQ)

Question	Answer
What operating system can I use for the LaCie Rugged Safe?	The LaCie Rugged Safe works with the latest versions of Windows XP, Windows Vista, and Windows 7; as well as the latest versions of Mac OS 10.5 and 10.6.
How many fingerprints can be registered?	Up to ten fingerprints can be registered.
How many users can have access to a Rugged Safe drive?	A maximum of ten users can have access to a single Rugged Safe, including at least one administrator. More than one user may be granted administration privileges. LaCie recommends a minimum of two administrators since one person is rarely available all the time.
What should I do if the Rugged Safe drive remains locked after swiping my finger?	<ul style="list-style-type: none"> ◆ Confirm that you are swiping your finger in the right direction (the front of the drive should be facing you) and that you are touching the sensor for at least one second but no more than five seconds. ◆ Be sure to wait a few seconds after connecting the LaCie Rugged Safe to your computer. ◆ Check with the administrator to make sure that you are registered and that you are using the correct finger. ◆ Try cleaning the sensor with a dry, soft cloth or disconnecting and reconnecting the USB 2.0 or FireWire 800 cable. <p>If the problem persists, consult section 8.2. Troubleshooting the Fingerprint Sensor for more suggestions.</p>
How can an administrator be changed?	An administrator can be changed on the LaCie Safe Manager Administration page (5.2. Manage Your Rugged Safe).
How can the authorized users be changed?	Only users with administration privileges can add or remove users.
Should I keep a backup of the data stored on the Rugged Safe?	LaCie recommends at least one backup of your data. To facilitate backups, the drive comes with Intego for Mac and Genie for Windows.
Do I need to install LaCie Safe Manager on all the computers that will share the Rugged Safe?	No, the Rugged Safe does not require any special software to run on multiple computers. Just connect the Rugged Safe drive to the computer following the instructions in section 3. Connecting Your LaCie Rugged Safe and an authorized user can swipe his finger over the sensor to access the drive. The drive will not appear in My Computer/Computer (Windows) or the desktop (Mac) until an authorized user has swiped his finger.
Can users change their profiles or remove other users?	Only users with administration privileges can add or remove users and change user profiles. Users without administration rights may modify their fingerprint(s) and password.
Are my fingerprints stored on the Rugged Safe?	The data for recognizing fingerprints is encrypted and stored locally on the drive. This data cannot be copied and/or corrupted.
Can I open the case on the Rugged Safe?	Removing the Rugged Safe casing will void the product warranty.

Question	Answer
What is the probability that a fingerprint from an unauthorized user can unlock the Rugged Safe?	Such an event is nearly impossible due to the biometry technology. Each human has his own biological identity, including unique fingerprints, thus making unauthorized entry all but unthinkable. To provide further assurance, LaCie has selected a sensor known for its precision.
What happens if the fingerprint sensor is damaged?	Please contact LaCie Customer Support. Make certain to back up all stored data in the event that you have to return the Rugged Safe.
What happens if the administrator is not available?	LaCie highly recommends giving at least two people Administration privileges in case one person leaves the company or is not available. LaCie does not take responsibility in the event that the Administrator becomes unavailable to access the data on the LaCie Rugged Safe.
Can the Rugged Safe be used on a network?	The LaCie Rugged Safe can only be used via USB 2.0 or FireWire 800/400 interfaces.
What do the LED colors indicate?	If the LED is: <ul style="list-style-type: none">◆ Blinking Red: the disk is locked and waiting for an authorized user to swipe his registered finger; or, the finger swipe failed.◆ Static Orange, the disk is attempting to recognize a fingerprint◆ Fixed Green, the drive is unlocked◆ Blinking Green, data is being accessed

8. Troubleshooting

In the event that your LaCie Rugged Safe is not working correctly, please refer to the following checklist to discover the source of the problem. If you have gone through all of the points on the checklist and your drive is still not working correctly, please have a look at the FAQs that are regularly published on our web site – www.lacie.com.

One of these FAQs may provide an answer to your specific question. LaCie encourages you to also visit the drivers page to find the most recent software updates. If you need further assistance, please contact your LaCie reseller or LaCie Technical Support (see section 9. *Contacting Customer Support* for details).

Manual Updates

LaCie strives to give you the most up-to-date, comprehensive User Manuals available on the market. It is our goal to provide you with a friendly, easy-to-use format that will help you quickly install and utilize the many functions of your new device.

If your User Manual does not reflect the configuration of the product you purchased, please check our web site for the most current version of the user manual.

www.lacie.com

8.1. Troubleshooting the Hard Drive

8.1.1. Mac Users

Problem	Question	Answer
The drive is not recognized by the computer.	Does an icon for the drive appear on the desktop?	There should be an icon for the LaCie drive on the desktop. If the drive does not appear, follow the rest of the Troubleshooting tips to isolate the problem.
	Does your computer's configuration meet the minimum system requirements for use with this drive?	Check section 1.4. <i>Minimum System Requirements</i> for more information.
	Is the drive receiving adequate power?	Connect the optional power-sharing cable. See section 3.3. <i>Connecting the Optional Power-Sharing Cable (USB)</i> for details.
	Did you follow the correct installation steps for the specific interface and operating system?	Review the installation steps in section 3.1. <i>Connecting the Interface Cable</i> .
	Are both ends of the interface cable firmly attached?	Check both ends of the FireWire or USB cables and make sure that they are fully seated in their respective ports. Disconnect the cables, wait ten seconds, and then reconnect them. If the drive is still not recognized, restart your computer and try again.
	Is the drive unlocked?	Check section 5. <i>Using Your LaCie Rugged Safe</i> .
	Are the USB and/or FireWire drivers installed correctly and enabled?	Open Apple System Profiler and click on the Devices and Volumes tab. If your device is not listed, recheck the cables and try the other troubleshooting tips listed here.
	Is there a conflict with other device drivers or extensions?	Contact LaCie Technical Support for help.

continued on the next page >>

Problem	Question	Answer
The drive is not recognized by the computer.	Has the drive been formatted?	Make sure that the drive has been formatted properly. Please see section 6. Formatting Your LaCie Rugged Safe for more details.
	Does your computer's operating system support the file system?	Check your computer's documentation and see section 6. Formatting Your LaCie Rugged Safe for more details.
The drive turns on and off when you turn your computer on and off.	This is normal. Your drive has an auto-switching power feature, which means that turning the computer on will automatically turn the drive on. Likewise, turning the computer off will automatically turn the drive off. For the auto-switching power feature to work, the drive must be connected to the computer. If you wish to power off the drive while it is connected to your computer, first make sure that your computer is not accessing the drive and then follow the steps in section 3.5. Disconnecting Your Hard Drive . Please note that the Rugged Safe will lock automatically each time the computer is put into Sleep mode or shut off.	
Error messages under Mac OS 10.x.	Did you get an "Error -50" message while copying to a FAT32 volume?	When copying files or folders from Mac OS 10.x to a FAT32 volume, certain characters cannot be copied. These characters include, but are not limited to: ? < > / \ : Check your files and folders to ensure that these types of characters are not being used.
	Did you get an error message telling you that the drive has been disconnected when coming out of sleep mode?	Simply ignore this message. The drive will remount to the desktop. LaCie drives conserve power by spinning down when you set your computer to sleep mode, and when the computer is "woken" from sleep, it does not give the drive enough time to spin-up from its sleep mode.
The drive is working slowly.	Are there other USB or FireWire devices connected to the same port or hub?	Disconnect any other USB or FireWire devices to determine if the drive's performance increases.
The drive is not running noticeably faster when connected via Hi-Speed USB 2.0.	Are you operating in Mac OS 10.x?	To achieve Hi-Speed USB 2.0 transfer rates, your computer must have a native USB 2.0 port. You may also add a Hi-Speed USB 2.0 PCI card (desktop) or a USB 2.0 PCMCIA (laptop) card to your computer.
	Is the drive connected to a USB port on your computer, or to a USB hub?	If your drive is connected to a USB port or hub, this is normal. A Hi-Speed USB 2.0 device can only operate at Hi-Speed USB 2.0 performance levels when it is connected directly to a Hi-Speed USB 2.0 port or hub. Otherwise, the Hi-Speed USB 2.0 device will operate at the slower USB transfer rates.
	Is the drive connected to a Hi-Speed USB 2.0 port on your computer?	Check to see that the Hi-Speed USB 2.0 drivers for both your host bus adapter and device have been installed correctly. If in doubt, un-install the drivers and re-install them.
The drive is not running noticeably faster when connected via Hi-Speed USB 2.0.	Does your computer or operating system support Hi-Speed USB 2.0?	See section 1.4. Minimum System Requirements .

8.1.2. Windows Users

Problem	Question	Answer
The drive is not recognized by the computer.	Has the drive been formatted?	Make sure that the drive has been formatted properly. Please see section 6. Formatting Your LaCie Rugged Safe for more details.
	Does your computer's operating system support the file system?	Check your computer's documentation and see section 6. Formatting Your LaCie Rugged Safe for more details.
	Is there an icon for the drive in My Computer/Computer ?	Go into My Computer/Computer and look for an icon and drive letter assigned to the LaCie drive. If the drive does not appear, follow the rest of the Troubleshooting tips to isolate the problem.
	Does your computer's configuration meet the minimum system requirements for use with this drive?	Check section 1.4. Minimum System Requirements for more information.
	Is the drive receiving adequate power?	Connect the optional power-sharing cable. (3.3. Connecting the Optional Power-Sharing Cable (USB))
	Did you follow the correct installation steps for the specific interface and operating system.	Review the installation steps in section 3. Connecting Your LaCie Rugged Safe .
	Are both ends of the FireWire or USB cables firmly attached?	Check both ends of the FireWire or USB cables and make sure that they are fully seated in their respective ports. Disconnect the cables, wait ten seconds, and then reconnect them. If the drive is still not recognized, restart your computer and try again.
	Is the drive unlocked?	Check section 5. Using Your LaCie Rugged Safe .
The drive is not recognized by the computer.	Have the FireWire and/or USB drivers been installed correctly and enabled on your computer?	<p>Windows XP Users: Go to Start Menu > Control Panel > Performance and Maintenance > System > Hardware tab > Device Manager button > USB Controller or IEEE 1394 Controller. Click on the + sign next to the controller icon, and you should see your device listed.</p> <p>Windows Vista: Go to Start Menu>Settings>Control Panel>Device Manager>USB Controller or IEEE 1394 Controller. Click on the + sign next to the controller icon, and you should see your device listed.</p> <p>Windows 7: Go to Start Menu > Control Panel > Device Manager>Universal Serial Bus or IEEE 1394 Bus host controllers Click on the + sign next to the controller icon, and you should see your device listed.</p> <p>If you still can't see your device, recheck the cables and try the other troubleshooting tips listed here.</p>
	Is there a conflict with other device drivers or extensions?	Contact LaCie Technical Support for help.

Problem	Question	Answer
The drive turns on and off when you turn your computer on and off.	This is normal. Your drive has an auto-switching power feature, which means that turning the computer on will automatically turn the drive on. Likewise, turning the computer off will automatically turn the drive off. For the auto-switching power feature to work, the drive must be connected to the computer. If you wish to power off the drive while it is connected to your computer, first make sure that your computer is not accessing the drive and then follow the steps in section 3.5. Disconnecting Your Hard Drive . Please note that the Rugged Safe will lock automatically each time the computer is put into Standby mode or shut off.	
The drive is working slowly.	Are there other USB or FireWire devices connected to the same port or hub?	Disconnect other USB or FireWire devices to see if the drive's performance increases.
The drive is not running noticeably faster when connected via Hi-Speed USB 2.0.	Is the drive connected to a USB port on your computer, or to a USB hub?	If your drive is connected to a USB port or hub, this is normal. A Hi-Speed USB 2.0 device can only operate at Hi-Speed USB 2.0 performance levels when it is connected directly to a Hi-Speed USB 2.0 port or hub. Otherwise, the Hi-Speed USB 2.0 device will operate at the slower USB transfer rates.
	Is the drive connected to a Hi-Speed USB 2.0 port on your computer?	Check to see that the Hi-Speed USB 2.0 drivers for both your host bus adapter and device have been installed correctly. If in doubt, uninstall the drivers and re-install them.
	Does your computer or operating system support Hi-Speed USB 2.0?	See section 1.4. Minimum System Requirements .
	Are you using a certified Hi-Speed USB 2.0 cable to connect your drive?	Ensure that the cable you are using has been properly certified. The Hi-Speed USB 2.0 cable that was shipped with your LaCie drive has been properly certified and tested to comply with USB standards.

8.2. Troubleshooting the Fingerprint Sensor

In the event that your LaCie Rugged Safe's fingerprint sensor does not recognize you as an authorized user, please refer to the following checklist. If you have gone through all of the points on the checklist and the fingerprint sensor still does not recognize an authorized fingerprint, please refer to the FAQs that are regularly published on our web site: www.lacie.com. One of these FAQs may provide an answer to your specific question. You can also visit the drivers page to view the most recent software updates.

If you need further assistance, please contact your LaCie reseller or LaCie Technical Support. See section 9. [Contacting Customer Support](#) for details.

If you are having problems with your LaCie Rugged Safe, see section 8. [Troubleshooting](#).

Try one or all of the following if you experience some difficulty with the fingerprint sensor:

- ◆ Make sure the front of the drive is facing you.
 - ◆ Make sure your finger is positioned properly. It should be flat and resting entirely on the sensor surface so that it touches the metal plate around the sensor itself.
 - ◆ Try using a second registered finger.
 - ◆ Try keeping your finger on the sensor for a longer period of time.
 - ◆ Clean the sensor with a dry tissue or cloth.
 - ◆ If you have dry skin, try touching your finger to your forehead or the side of your nose and then placing your finger on the sensor.
 - ◆ If you have moist skin, try rubbing your finger on your slacks or shirt sleeve and then place your finger on the unit.
 - ◆ Disconnect and then reconnect the drive.
-

9. Contacting Customer Support

Before You Contact Technical Support:

Read the User Manual and review the Troubleshooting section.

Try to isolate the problem. If possible, make the drive the only external device on the CPU, and make sure that all of the cables are correctly and firmly attached.

If you have asked yourself all of the pertinent questions in the troubleshooting checklist and you still can't get your LaCie drive to work properly, refer to the contacts on the following page. Before contacting us, make sure that you are in front of your computer and that you have the following information on hand:

Information	Where to Find Information
LaCie Rugged Safe serial number	Located on a sticker at the back of drive or on the original packaging
LaCie Rugged Safe file format	<p>Mac users: Select the Rugged Safe icon on the desktop and press Command + I, or press the Control key and choose Get Info.</p> <p>Windows users: Right click the Rugged Safe icon and select Properties.</p>
Macintosh/PC model	<p>Mac users: Click on the Apple icon in the menu bar and select About this Mac.</p> <p>Windows users: Right click My Computer and select Properties > General.</p>
Operating system	
Processor speed	
Computer memory	
The brands and models of other internal and external peripherals installed on the computer	<p>Mac users: Click on the Apple icon in the finder bar and select About this Mac. Select More Info... The Apple System Profiler will launch and will list your internal and external peripherals.</p> <p>Windows users: Right click My Computer and select Properties > Hardware.</p>

9.1. LaCie Technical Support Contacts

<p>LaCie Asia http://www.lacie.com/cn/contact/</p>	<p>LaCie Australia http://www.lacie.com/au/contact/</p>
<p>LaCie Belgium http://www.lacie.com/be/contact/ (Dutch) http://www.lacie.com/befr/contact/ (French)</p>	<p>LaCie Brazil http://www.lacie.com/us/contact</p>
<p>LaCie Canada http://www.lacie.com/ca/contact/ (English) http://www.lacie.com/cafr/contact/ (French)</p>	<p>LaCie Denmark http://www.lacie.com/dk/contact</p>
<p>LaCie Finland http://www.lacie.com/fi/contact/</p>	<p>LaCie France http://www.lacie.com/fr/contact/</p>
<p>LaCie Germany http://www.lacie.com/de/contact/</p>	<p>LaCie Ireland http://www.lacie.com/ie/contact/</p>
<p>LaCie Italy http://www.lacie.com/it/contact/</p>	<p>Japan - Elecom CO., LTD http://www.lacie.jp/</p>
<p>LaCie Korea http://www.lacie.com/kr/contact</p>	<p>LaCie Latin America http://www.lacie.com/la/contact/</p>
<p>LaCie Netherlands http://www.lacie.com/nl/contact/</p>	<p>LaCie Norway http://www.lacie.com/no/contact/</p>
<p>LaCie Portugal http://www.lacie.com/pt/contact/</p>	<p>LaCie Singapore http://www.lacie.com/asia/contact/</p>
<p>LaCie Southeast Asia http://www.lacie.com/sea/contact</p>	<p>LaCie Spain http://www.lacie.com/es/contact/</p>
<p>LaCie Sweden http://www.lacie.com/se/contact</p>	<p>LaCie Switzerland http://www.lacie.com/ch/contact (German) http://www.lacie.com/chfr/contact/ (French) http://www.lacie.com/chit/contact/ (Italian)</p>
<p>LaCie UK http://www.lacie.com/uk/contact</p>	<p>LaCie USA http://www.lacie.com/us/contact/ (English) http://www.lacie.com/uses/contact (Spanish)</p>
<p>LaCie Grand Export http://www.lacie.com/intl/contact/</p>	

10. Warranty Information

LaCie warrants your drive against any defect in material and workmanship, under normal use, for the period designated on your warranty certificate. In the event this product is found to be defective within the warranty period, LaCie will, at its option, repair or replace the defective drive. This warranty is void if:

- ◆ The drive was operated/stored in abnormal use or maintenance conditions;
- ◆ The drive is repaired, modified or altered, unless such repair, modification or alteration is expressly authorized in writing by LaCie;
- ◆ The drive was subjected to abuse, neglect, lightning strike, electrical fault, improper packaging or accident;
- ◆ The drive was installed improperly;
- ◆ The serial number of the drive is defaced or missing;
- ◆ The broken part is a replacement part such as a pickup tray, etc.
- ◆ The tamper seal on the drive casing is broken.

LaCie and its suppliers accept no liability for any loss of data during the use of this device, or for any of the problems caused as a result.

LaCie will not, under any circumstances, be liable for direct, special or consequential damages such as, but not limited to, damage or loss of property or equipment, loss of profits or revenues, cost of replacement goods, or expense or inconvenience caused by service interruptions.

Any loss, corruption or destruction of data while using a LaCie drive is the sole responsibility of the user, and under no circumstances will LaCie be held liable for the recovery or restoration of this data.

Under no circumstances will any person be entitled to any sum greater than the purchase price paid for the drive.

To obtain warranty service, call LaCie Technical Support. You will be asked to provide your LaCie product's serial number, and you may be asked to furnish proof of purchase to confirm that the drive is still under warranty.

All drives returned to LaCie must be securely packaged in their original box and shipped with postage prepaid.

IMPORTANT INFO: Register online for free technical support: www.lacie.com/register

Note to Australian Customers

Our goods come with guarantees that cannot be excluded under the Australian Consumer Law. You are entitled to a replacement or refund for a major failure and for compensation for any other reasonably foreseeable loss or damage. You are also entitled to have the goods repaired or replaced if the goods fail to be of acceptable quality and the failure does not amount to a major failure.

Contact us:

LaCie Australia, 458 Gardeners Road Alexandria, NSW 2015 AUSTRALIA.

Phone: 02 8063 3711

Email: info.au@lacie.com

For fast technical support, create a support ticket after registering your product at <http://www.lacie.com/au/register>.